



**Katalog
Catalogue**

**Catalog
Catálogo**

2018-01



ⓓ Inhaltverzeichnis

Symbol-Erläuterungen	6
Sicherheitshinweis	14
Typenübersicht Sägeketten und Führungsschienen	20
Sägeketten für STIHL Motorsägen / Hochentaster	22
Führungsschienen für STIHL Motorsägen / Hochentaster	36
STIHL Sägeketten für Fremdfabrikate	54
Vergleichstabelle STIHL Sägeketten / Fremdfabrikate	96
STIHL Oilomatic-Kettenrollen	98
Ersatzteile für STIHL Sägeketten	100
Ersatzteile für STIHL Führungsschienen	104
STIHL GS 461	106

Ⓞ Contents

Explanation of symbols	6
Safety Instructions	14
Type overview of saw chains and guide bars	20
Saw chains for STIHL chain saws / pole pruners	22
Guide bars for STIHL chain saws / pole pruners	36
STIHL saw chains for external brands	54
Comparison table STIHL saw chains / external brands	96
STIHL Oilomatic chain roll	98
Spare parts for STIHL saw chains	100
Spare parts for STIHL guide bars	104
STIHL GS 461	106

ⓕ Table des matières

Explication des symboles	6
Prescriptions de sécurité	14
Aperçu des types de chaînes et guide-chaînes	20
Chaînes pour tronçonneuses / perches élagueuses STIHL	22
Guide-chaînes pour tronçonneuses / perches élagueuses STIHL	36
Chaînes STIHL pour machines d'autres marques	54
Tableau de comparaison chaînes STIHL / produits d'autres marques	96
Rouleaux de chaînes STIHL Oilomatic	98
Pièces de rechange pour chaînes STIHL	100
Pièces de rechange pour guide-chaînes STIHL	104
STIHL GS 461	106

ⓔ Sumario

Aclaraciones de símbolos	6
Indicación relativa a la seguridad	14
Sinopsis de modelos de cadenas y espadas	20
Cadenas para motosierras/podadoras de altura STIHL	22
Espadas para motosierras/podadoras de altura STIHL	36
Cadenas STIHL para motosierras de otras marcas	54
Tabla comparativa de cadenas/motosierras de otras marcas	96
Rollos de cadenas STIHL Oilomatic	98
Piezas de repuesto para cadenas STIHL	100
Piezas de repuesto para espadas STIHL	104
STIHL GS 461	106

Ⓟ Índice

Explicações dos símbolos	6
Indicação de segurança	14
Vista de conjunto dos tipos de correntes e guias	20
Correntes para as moto-serras / podadoras da STIHL	22
Guias para as moto-serras / podadoras da STIHL	36
Correntes da STIHL para produtos alheios	54
Tabela comparativa das correntes da STIHL / dos produtos alheios	96
Rolos de correntes Oilomatic da STIHL	98
Peças de reposição para as correntes da STIHL	100
Peças de reposição para as guias da STIHL	104
STIHL GS 461	106

ⓖ Indice

Spiegazioni dei simboli	6
Avvertenza per la sicurezza	14
Sommario dei tipi di catene e di spranghe di guida	20
Catene per motoseghe / sramatori lunghi STIHL	22
Spranghe di guida per motoseghe / sramatori lunghi STIHL	36
Catene STIHL per prodotti di altri costruttori	54
Tabella di confronto catene STIHL / prodotti terzi	96
Rulli di catene STIHL Oilomatic	98
Parti di ricambio per catene STIHL	100
Parti di ricambio per spranghe STIHL	104
STIHL GS 461	106

ⓗ Inhoudsopgave

Symbolverklaring	6
Veiligheidsinstructie	14
Typeoverzicht zaagkettingen en zaagbladen	20
Zaagkettingen voor STIHL motorzagen/hoogsnoeiers	22
Zaagbladen voor STIHL motorzagen/hoogsnoeiers	36
STIHL zaagkettingen voor andere merken	54
Vergelijkingstabel STIHL zaagkettingen/andere merken	96
STIHL Oilomatic-kettingrollen	98
Onderdelen voor STIHL zaagkettingen	100
Onderdelen voor STIHL zaagbladen	104
STIHL GS 461	106

Ⓢ Innehållsförteckning

Symbolförklaringar	6
Säkerhetsanvisningar	14
Typöversikt sågkedjor och svärd	20
Sågkedjor för STIHL motorsågar/stamkvistare	22
Svärd för STIHL motorsågar/stamkvistare	36
STIHL sågkedjor för andra märken	54
Jämförelsetabell STIHL sågkedjor/andra märken	96
STIHL Oilomatic-kedjerullar	98
Reservdelar för STIHL sågkedjor	100
Reservdelar för STIHL svärd	104
STIHL GS 461	106

N Innholdsfortegnelse

Symbolforklaringer	6
Sikkerhetsanvisning	14
Typeoversikt sagkjeder og sverd	20
Sagkjeder til motorsager / grensager fra STIHL	22
Sverd til motorsager / grensager fra STIHL	36
STIHL sagkjeder til fabrikater fra andre produsenter	54
Sammenligningstabell STIHL sagkjeder / fabrikater fra andre produsenter	96
STIHL Oilomatic-kjederuller	98
Reservedeler til STIHL sagkjeder	100
Reservedeler til STIHL sverd	104
STIHL GS 461	106

FIN Sisällys

Merkkien selitykset	6
Turvallisuusohje	14
Teräketjut ja terälevyt	20
STIHL moottorisahojen ja oksasahojen teräketjut	22
STIHL moottorisahojen ja oksasahojen terälevyt	36
STIHL teräketjut muiden valmistajien tuotteisiin	54
Vertailutaulukko STIHL teräketjut / muut valmistajat	96
STIHL Oilomatic-ketjurullat	98
STIHL teräketjujen varaosat	100
STIHL terälevyjen varaosat	104
STIHL GS 461	106

DK Indholdsfortegnelse

Symbolforklaringer	6
Sikkerhedshenvisning	14
Typeoversigt savkæder og sværd	20
Savkæder til STIHL motorsave/teleskopsave	22
Sværd til STIHL motorsave/teleskopsave	36
STIHL savkæder til fremmed-fabrikater	54
Sammenligningstabel STIHL savkæder/fremmed-fabrikater	96
STIHL Oilomatic-kæderuller	98
Reserve dele til STIHL savkæder	100
Reserve dele til STIHL sværd	104
STIHL GS 461	106

GR Πίνακας περιεχομένων

Επεξήγηση συμβόλων	6
Οδηγίες ασφαλείας	14
Αλυσίδες και λάμες: Επισκόπηση τύπων	20
Αλυσίδες κοπής για (τηλεσκοπικά) αλυσοπρίονα STIHL	22
Λάμες για (τηλεσκοπικά) αλυσοπρίονα STIHL	36
Αλυσίδες κοπής STIHL για προϊόντα άλλων κατασκευαστών	54
Αλυσίδες κοπής STIHL / άλλων κατασκευαστών:	
Συγκριτικός πίνακας	96
Ρολά αλυσίδας STIHL Oilomatic	98
Ανταλλακτικά για αλυσίδες STIHL	100
Ανταλλακτικά για λάμες STIHL	104
STIHL GS 461	106

TR İçindekiler

Sembollerin açıklaması	6
Emniyet Uyarısı	14
Zincirli testereler ve kılavuzların modellerine dair tablo	20
STIHL motorlu testereleri için zincirler/yüksekte budama aparatları	22
STIHL motorlu testereleri için kılavuzlar/ yüksekte budama aparatları	36
Başka şirketlerin ürünleri için STIHL testere zincirleri	54
STIHL testere zincirleri ile karşılaştırmalı tabela/başka şirketlerin ürünleri	96
STIHL Oilomatic- zincir makaraları	98
STIHL testere zincirleri için yedek parçalar	100
STIHL kılavuzları için yedek parçalar	104
STIHL GS 461	106

HR Popis sadržaja

Pojašnjenja simbola	6
Uputa o sigurnosti u radu	14
Pregled tipova lanaca pile i vodilica	20
Lanci pile za motorne pile / kresače visokih grana tvrtke STIHL	22
Vodilice za motorne pile / kresače visokih grana tvrtke STIHL	36
Lanci pile tvrtke STIHL za strane proizvođače	54
Poredbena tabela, lanci pile tvrtke STIHL / strani proizvođači	96
Oilomatic-role/koturi s lancima tvrtke STIHL	98
Pričuvni dijelovi za lance pile tvrtke STIHL	100
Pričuvni dijelovi za vodilice tvrtke STIHL	104
STIHL GS 461	106

SLO Kazalo vsebine

Razlage simbolov	6
Varnostni napotek	14
Pregled tipov verig in mečev	20
Verige za motorne žage/višinske obvejevalnike STIHL	22
Meči za motorne žage/višinske obvejevalnike STIHL	36
Verige STIHL za izdelke drugih proizvajalcev	54
Primerjalna tabela verig STIHL/izdelkov drugih proizvajalcev	96
Veržniki Oilomatic STIHL	98
Nadomestni deli za verige STIHL	100
Nadomestni deli za meče STIHL	104
STIHL GS 461	106

SRB Pregled sadržaja

Objašnjenje simbola	6
Sigurnosna napomena	14
Pregled tipova reznih lanaca i vodilica	20
Rezni lanci za STIHL motorne testere / potkresivače grana	22
Vodilice za STIHL motorne testere / potkresivače grana	36
STIHL rezni lanci za proizvode drugih proizvođača	54
Usporedna tabela - STIHL rezni lanci / proizvodi drugih proizvođača	96
STIHL lančanići za Oilomatic rezne lance	98
Rezervni delovi za STIHL rezne lance	100
Rezervni delovi za STIHL vodilice	104
STIHL GS 461	106

🇨🇿 Obsah

Vysvělení symbolů	6
Bezpečnostní upozornění	14
Přehled typů pilových řetězů a vodičích lišt	20
Pilové řetězy pro motorové pily / vyvětřovací pily STIHL	22
Vodičí lišty pro STIHL motorové pily / vyvětřovací pily STIHL	36
Pilové řetězy STIHL pro cizí výrobky	54
Porovnávací tabulka pilových řetězů STIHL / cizích výrobků	96
Řetězové role STIHL Oilomatic	98
Náhradní díly pro pilové řetězy STIHL	100
Náhradní díly pro vodičí lišty STIHL	104
STIHL GS 461	106

🇸🇰 Obsah

Vysvetlenie symbolov	6
Bezpečnostné upozornenie	14
Prehľad typov pilových reťazí a vodiacich lišt	20
Pilové reťaze pre motorové pily/vyvětřovací pily STIHL	22
Vodiace lišty pre motorové pily/vyvětřovací pily STIHL	36
STIHL pilové reťaze pre výrobky iných značiek	54
Porovnávacia tabuľka STIHL pilové reťaze/výrobky iných značiek	96
STIHL reťazová kladka Oilomatic	98
Náhradné diely pre pilové reťaze STIHL	100
Náhradné diely pre vodiace lišty STIHL	104
STIHL GS 461	106

🇭🇺 Tartalomjegyzék

A szimbólumok magyarázatai	6
Biztonsági tudnivalók	14
A fűrészláncok és a vezetőlemezek típusainak áttekintése	20
Fűrészláncok STIHL motorfűrészekhez / magassági ágyasókhöz	22
Vetőlemez STIHL motorfűrészekhez / magassági ágyasókhöz	36
STIHL fűrészláncok más cégek készülékeihez	54
A STIHL fűrészláncok / más cégek által forgalmazott termékek összehasonlító táblázata	96
STIHL Oilomatic láncgörgők	98
Pótalkatrészek STIHL fűrészláncokhoz	100
Pótalkatrészek STIHL vezetőlemezekhez	104
STIHL GS 461	106

🇵🇱 Spis treści

Objaśnienia do symboli	6
Wskazówka bezpieczeństwa	14
Przegląd typów pił łańcuchowych i prowadnic	20
Piły łańcuchowe do pilarek spalinowych / podkrzesywarek STIHL	22
Prowadnice do pilarek spalinowych / podkrzesywarek STIHL	36
Piły spalinowe STIHL do narzędzi innych producentów	54
Tabela porównująca piły spalinowe STIHL / innych producentów	96
Rolki łańcuchowe STIHL Oilomatic	98
Części zamienne do pił spalinowych STIHL	100
Części zamienne do prowadnic STIHL	104
STIHL GS 461	106

🇷🇺 Оглавление

Обозначение символов	6
Указание по безопасности	14
Обзор типов пильных цепей и направляющих шин	20
Пильные цепи для бензопил / высоторезов STIHL	22
Направляющие шины для бензопил / высоторезов STIHL	36
Пильные цепи STIHL для изделий других производителей	54
Сравнительная таблица STIHL Пильные цепи / Изделия других производителей	96
Цепные ролики STIHL Oilomatic	98
Запасные части для пильных цепей STIHL	100
Запасные части для направляющих шин STIHL	104
STIHL GS 461	106

🇬🇧 Съдържание

Обяснения на символите	6
Указание за безопасност	14
Преглед на типове режещи вериги и шини	20
Режещи вериги за моторни триони / прътови кастрачки STIHL	22
Шини за моторни триони / прътови кастрачки STIHL	36
Режещи вериги STIHL за изделия на други производители	54
Сравнителна таблица на STIHL режещи вериги / изделия на други производители	96
STIHL верижни ролки тип "Oilomatic"	98
Резервни части за режещи вериги на STIHL	100
Резервни части за шини на STIHL	104
STIHL GS 461	106

RO Cuprins

Explicația simbolurilor	6
Indicație privitoare la siguranță	14
Privire de ansamblu asupra tipurilor de fierăstrău și de șine port-lanț	20
Lanțuri de fierăstrău pentru emondoare / motofierăstraie STIHL	22
Șine port-lanț pentru emondoare / motofierăstraie STIHL	36
Lanțuri de fierăstrău STIHL pentru produse de fabricație diferită	54
Tabel comparativ cu lanțuri de fierăstrău STIHL / produse de fabricație diferită	96
Role de lanț Oilomatic STIHL	98
Piese de schimb pentru lanțuri de fierăstrău STIHL	100
Piese de schimb pentru șine port-lanț STIHL	104
STIHL GS 461	106

J 目次

シンボルの説明	6
安全上の注意事項	14
ソーチェンとガイドバータイプの概要	20
STIHL チェンソー / 高枝カッター用ソーチェン	22
STIHL チェンソー / 高枝カッター用ガイドバー	36
他社ブランド用 STIHL ソーチェン	54
STIHL ソーチェン / 他社ブランドの比較表	96
STIHL オイロマチック チェン ロール	98
STIHL ソーチェン用スペア パーツ	100
STIHL ガイドバー用スペア パーツ	104
STIHL GS 461	106

RI Daftar isi

Penjelasan simbol	6
Petunjuk keselamatan	14
Ikhtisar jenis rantai gergaji dan batang pengantar	20
Rantai gergaji untuk gergaji mesin/pruner STIHL	22
Batang pengantar untuk gergaji mesin/pruner STIHL	36
Rantai gergaji STIHL untuk produsen lain	54
Tabel perbandingan rantai gergaji STIHL dan produsen lain	96
Roda rantai Oilomatic STIHL	98
Suku cadang untuk rantai gergaji STIHL	100
Suku cadang untuk batang pengantar STIHL	104
STIHL GS 461	106









PRC 目录

符号说明	6
安全说明	14
锯链和导板类型一览	20
STIHL 链锯 / 修枝锯用锯链	22
STIHL 链锯 / 修枝锯用导板	36
外部品牌用 STIHL 锯链	54
STIHL 锯链 / 外部品牌对照表	96
STIHL Oilomatic 成卷锯链	98
STIHL 锯链备件	100
STIHL 导板备件	104
STIHL GS 461	106







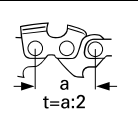
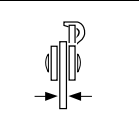
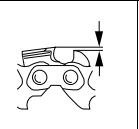
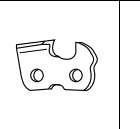
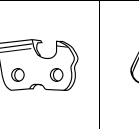
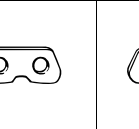
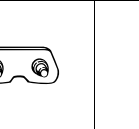
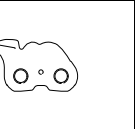

ROK 목차

기호 설명	6
안전 지침	14
체인날 및 안내판의 종류 개요	20
STIHL 기계톱/고지절단기용 체인날	22
STIHL 기계톱/고지절단기용 안내판	36
외부 브랜드용 STIHL 기계톱	54
STIHL 기계톱/외부 브랜드 비교 표	96
STIHL Oilomatic 체인 롤	98
STIHL 기계톱용 예비 부품	100
STIHL 안내판용 예비 부품	104
STIHL GS 461	106











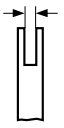
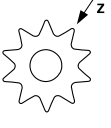
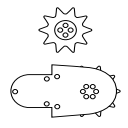



(D)	Nennschnitlänge	Ketten- teilung	Treibglied- dicke	Tiefenbe- greuzer- abstand	Schneide- zahn (links)	Schneide- zahn (rechts)	Verbindungs- glied ohne Niet	Verbindungs- glied mit Niet	Drei-Höcker- Verbindungsglied rechts
(GB)	Rated cutting length	Chain pitch	Drive link gauge	Depth gauge setting	Left hand cutter	Right hand cutter	Tie strap (without rivets)	Tie strap (with rivets)	Triple-hump tie strap, right-hand
(F)	Longueur de coupe nominale	Pas de chaîne	Jauge (maillon d'en- trainement)	Retrait du limiteur de profondeur	Dent de coupe (gauche)	Dent de coupe (droite)	Maillon inter- médiaire sans rivets	Maillon inter- médiaire avec rivets	Maillon intermé- diaire droit à trois bossages
(E)	Longitud de corte nominal	Paso de cadena	Grosor eslabón impulsor	Distancia del limitador de profundidad	Diente de corte (izquierda)	Diente de corte (derecha)	Eslabón de unión sin remache	Eslabón de unión con remache	Eslabón de unión de 3 corcovas, derecha
(P)	Comprimento de corte nominal	Passe da corrente	Espeçura do elo de ac- cionamento	Distância dos limitad. de profundidade	Dente de corte (à esquerda)	Dente de corte (à direita)	Elo de união sem rebite	Elo de união com rebite	Elo de união de três saliências à direita
(I)	Lunghezza di taglio	Passo catena	Spessore maglia di guida	Distanza limitatore di profondità	Dente (sinistro)	Dente (destro)	Maglia d'unione senza rivetto	Maglia d'unione con rivetto	Maglia d'unione a tre gobbe destra
(NL)	Nominale zaagbladleng- te	Kettingsteek	Dikte aandrijfschak- el	Dieptebe- grenzer- afstand	Zaagtand (links)	Zaagtand (rechts)	Verbindingss- chakel zonder	Verbindingss- chakel met klinknagel	Drieknobbelverbin- dingsschakel rechts
(S)	Märkskär- längd	Kedjedelning	Drivlänks- tjocklek	Underställ- ning	Skärlänk (vänster)	Skärlänk (höger)	Sidolänk utan nit	Sidolänk med nit	Sidolänk med tre pucklar höger
(N)	Nominell snittlengde	Kjededeling	Drivledd-tyk- kelse	Dybdebe- greuzerav- stand	Høveltann (venstre)	Høveltann (høyre)	Forbindelses- ledd uten nagle	Forbindelses- ledd med nagle	Forbindelsesledd med tre pukler, høyre
(FIN)	Sahauspi- tuus (nimel- isarvo)	Ketjujako	Vetolenkin paksuus	Syvyysääti- men väli	Leikkuu- hammas (vasen)	Leikkuu- hammas (oikea)	Sivulenkki ilman niittiä	Sivu- lenkki ja niitti	3-huippuinen sivulenkki oikea
(DK)	Nominel snit- længde	Kædedeling	Drivledstyk- kelse	Dybdebe- græuzerav- stand	Skæretand (venstre)	Skæretand (højre)	Forbindelses- led uden nitte	Forbindelses- led med nitte	Forbindelsesled med tre forhøjnin- ger, højre
(GR)	Όνομαστικό μήκος κοπής	Βήμα αλυσίδας	Πάχος οδηγών	Απόσταση οδηγού βάθους	Δόντι κοπής (αριστερά)	Δόντι κοπής (δεξιά)	Συνδετήρας χωρίς πριτσίνι	Συνδετήρας με πριτσίνι	Δεξιός συνδετήρας τριών εξογκωμάτων
(TR)	Nominal kesim uzunluğu	Zincir piçi ölçüsü	Tahrik baklasının kalınlığı	Derinlik tırnağının mesafesi	Kesici diş (sol)	Kesici diş (sağ)	Perçinsiz bağlantı baklası	Perçinli bağlantı baklası	Üç tepeli bağlantı baklası sağ
(HR)	Nazivna duljina reza	Podjela lanaca	Debljina pogonske karike	Razmak omeđivača dubine	Zub za rezanje (lijevo)	Zub za rezanje (desno)	Spojna karika bez zakovice	Spojnakarika sa zakovicom	Trogrba spojna karika desno
(SLO)	Nazivna dolžina reznaja	Delitev verige	Debelina pogonskega člena	Razmik omejevalnika globine	Rezalni zob (levo)	Rezalni zob (desno)	Vezni člen (brez kovice)	Vezni člen (s kovico)	Trigrbni vezni člen, desno
(SRB)	Nominalna rezna dužina	Podela lanca	Debljina pogonske karike	Rastojanje dubinskog graničnika	Rezni zubac (levo)	Rezni zubac (desno)	Spojna karika (bez zakovice)	Spojna karika (sa zakovicom)	Trogrba spojna karika desno
(CZ)	Jmenovitá řezná délka	Rozteč řetězu	Tloušťka vodícího článku	Vzdálenost omezovače hloubky	Řezný zub (levý)	Řezný zub (pravý)	Spojovací článek bez nýtu	Spojovací článek s nýtem	Bezpečnostní spojovací článek pravý
(SK)	Menovitá rezná dĺžka	Rozstup reťaze	Hrúbka vodiaceho článku	Vzdialenosť obmedzovač a hĺbky	Rezný zub (vľavo)	Rezný zub (vpravo)	Spojovací článok (bez nitu)	Spojovací článok (s nitom)	Spojovací článok s tromi výstupkami
(H)	Névleges vágási hossz	Láncosztás	A vezetőszem vastagsága	A mélységátár oló távolsága	Vágófog (bal oldali)	Vágófog (jobb oldali)	Összekötősz- em (szegeccs nélkül)	Összekötősz- em (szegeccsel)	Hárombütykös összekötőszem, jobb







								
Drei-Höcker-Verbindungsglied links	Treibglied	Höckertreibglied	Kettentyp	Kettenrolle	Länge der Kettenrolle	Durchmesser Rundfeile	Feilenhalter mit Rundfeile	(D)
Triple-hump tie strap, left-hand	Drive link	Humped drive link	Chain type	Chain roll	Length of chain roll	Diameter of round file	File holder with round file	(GB)
Maillon intermédiaire gauche à trois bossages	Maillon d'entraînement	Maillon d'entraînement à bossage(s)	Type de chaîne	Rouleau de chaîne	Longueur du rouleau de chaîne	Diamètre de lime ronde	Porte-lime avec lime ronde	(F)
Eslabón de unión de 3 corcovas, izquierda	Eslabón impulsor	Eslabón de corcova	Tipo de cadena	Rollo de cadena	Longitud del rollo de cadena	Diámetro de la lima redonda	Portalimas con lima redonda	(E)
Elo de união de três saliências à esquerda	Elo de accionamento	Elo de união com saliências	Tipo de corrente	Rolo de correntes	Comprimento do rolo de correntes	Diâmetro Lima redonda	Porta-limas com lima redonda	(P)
Maglia d'unione a tre gobbe sinistra	Maglia di guida	Maglia di guida a gobba	Tipo di catena	Rullo di catena	Lunghezza del rullo di catena	Diametro lima tonda	Portalima con lima tonda	(I)
Drieknobbelverbindingsschakel links	Aandrijfschakel	Knobbelaandrijf schakel	Kettingtype	Kettingrol	Lengte kettingrol	Diameter ronde vijl	Vijlhouder met ronde vijlen	(NL)
Sidolänk med tre pucklar, vänster	Drivlänk	Drivlänk med puckel	Kedjetyp	Kedjerulle	Kedjerullens längd	Diameter rundfil	Filhållare med rundfil	(S)
Sideledd med tre forhøyninger, venstre	Drivledd	Forhøyningsdrivledd	Kjedetype	Kjederull	Lengde på kjederull	Diameter på rundfil	Filholder med rundfil	(N)
Vasen kolmihuippuinen sivulenkki	Vetolenkki	Huipullinen vetolenkki	Ketjutyyppi	Ketjupyörä	Ketjupyörän pituus	Pyöröviilan halkaisija	Viilanpidin ja pyöröviila	(FIN)
Forbindelsesled med treforhøjninger,	Drivled	Höcker-drivled	Kædetype	Kæderulle	Kæderullens længde	Diameter rundfil	Filholder med rundfil	(DK)
Αριστερός συνδετήρας τριών εξογκωμάτων	Οδηγός αλυσίδας	Οδηγός με εξογκώματα	Τύπος αλυσίδας	Ρολό αλυσίδας	Μήκος ρολού αλυσίδας	Διάμετρος στρογγυλής λίμας	Βάση λίμας με στρογγυλή λίμα	(GR)
Üç tepeli bağlantı baklası sol	Tahrik baklası	Tepeli tahrik baklası	Zincir tipi	Zincir makarası	Zincir makarasının uzunluğu	Yuvarlak eğenin çapı	Yuvarlak eđeli bileme kılavuzu	(TR)
Trogrba spojna karika lijevo	Pogonska karika	Grbava pogonska karika	Tip lanca	Rola/kotur s lancem	Duljina role/kotura s lancem	Promjer okrugle turpije	Držač turpije s okruglom turpijom	(HR)
Trigrbni vezni člen, levo	Pogonski člen	Grbasti pogonski člen	Tip verige	Verižnik	Dolžina verižnika	Premer okrogile pile	Držalo pile z okroglo pilo	(SLO)
Trogrba spojna karika levo	Pogonska karika	Pogonska karika sa ispučenjem	Tip lanca	Lančanik	Dužina lančanika	Prečnik okrugle turpije	Držač turpije sa okruglom turpijom	(SRB)
Bezpečnostní spojovací článok levý	Vodící článok	Bezpečnostní článok	Typ řetězu	Typ řetězu	Řetězová role	Délka řetězové role	Držák pilníku s kulatým pilníkem	(CZ)
Spojovací článok s tromi výstupkami vľavo	Vodiaci článok	Vodiaci článok s výstupkami	Typ reťaze	Reťazová kladka	Dĺžka reťazovej kladky	Priemer kruhového pilníka	Držiak pilníka s kruhovým pilníkom	(SK)
Hárombütykös összekötőszem, bal	Vezetőszem	Bütykös vezetőszem	Lánctípus	Láncgörgő	A láncgörgő hossza	A körreszelő átmérője	Reszelőtartó, kerek reszelővel	(H)











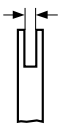
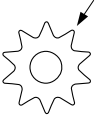
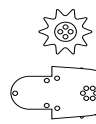







									
PL	Nominalna długość cięcia	Podziałka piły łańcuchowej	Grubość ogniwa napędowego	Odstęp ogranicznika zagłębienia	Ząb tnący (lewy)	Ząb tnący (prawy)	Ogniwo łączące bez nitu	Ogniwo łączące z nitem	Potrójne wygarbione ogniwo łączące
RUS	Номинальная длина реза	Шаг цепи	Толщина ведущего звена	Расстояние ограничителя глубины	Режущий зуб (слева)	Режущий зуб (справа)	Соединительное звено без заклепки	Соединительное звено с заклепкой	Трехбугорчатое соединительное звено справа
BG	Номинална дължина на рязане	Стъпка на веригата	Дебелина на водещото звено	Разстояние на ограничител	Режещ зъб (отляво)	Режещ зъб (отдясно)	Свързващо звено без нит	Свързващо звено с нит	Свързващо звено с три „Гърбици“
RO	Lungimea de tăiere nominală	Divizor pentru pasul lanțului	Grosime element de antrenare	Distanță limitator adâncime	Dinți de tăiere (stânga)	Dinți de tăiere (dreapta)	Element de legătură fără nit	Element de legătură cu nit	Element de legătură cu trei bosaje dreapta
J	定格切断長	チェーンのピッチ	ドライブリンクゲージ	デプスゲージの設定	左側ハンドルカッター	右側ハンドルカッター	タイストラップ (リベットなし)	タイストラップ (リベット付き)	3段タイストラップ (右手)
RI	Panjang pemotongan nominal	Pitch rantai	Ketebalan mata penggerak	Jarak pembatas kedalaman	Gigi potong (kiri)	Gigi potong (kanan)	Strap pengikat tanpa rivet	Strap pengikat rantai	Mata sambungan rantai jenis 3 hump kanan
PRC	公称切割长度	锯链节距	传动链节尺寸	深度规设置	左旋锯齿	右旋锯齿	连接片 (不带铆钉)	连接片 (带铆钉)	有三个隆起的连接片, 右旋
ROK	정격 절단 길이	체인 피치	구동 링크 게이지	깊이 게이지 설정	왼손잡이 톱날	오른손잡이 톱날	연결 고리 (리벳 없음)	연결 고리 (리벳 있음)	돌출부로 구성된 연결 고리, 오른손잡이

								
Potrójne wygarbione ogniwo łączące	Ogniwo napędowe	Wygarbione ogniwo łączące	Typ pily łańcuchowej	Rolka łańcuchowa	Długość rolki łańcuchowej	Średnica pilnika okrągłego	Uchwyt z pilnikiem okrągłym	PL
Трехбугорчатое соединительное звено слева	Ведущее звено	Бугорчатое ведущее звено	Серия цепи	Ролик цепи	Длина ролика цепи	Диаметр круглого напильника	Держатель с круглым напильником	RUS
Свързващо звено с три „Гърбици“ отляво	Водещо звено	Водещо звено с "гърбица"	Тип на веригата	Верижна ролка	Дължина на верижната ролка	Диаметър на кръглата пила	Пилодържател с кръгла пила	BG
Element de legătură cu trei bosaje stânga	Element de antrenare	Element de antrenare bosaj	Tip de lanț	Rolă de transmisie cu lanț	Lungimea rolei de transmisie cu	Diametru pilă rotundă	Suport de pilă cu pilă rotundă	RO
3 段タイストラップ (左手)	ドライブリンク	こぶ付きドライブリンク	チェーンのタイプ	チェーン ロール	チェーン ロールの長さ	丸ヤスリの直径	丸ヤスリ付き ファイルホルダー	J
Mata sambungan rantai jenis 3 hump kiri	Mata penggerak rantai	Mata penggerak rantai jenis	Jenis rantai	Roda rantai	Panjang roda rantai	Diameter kikir bundar	Gagang kikir dengan kikir bundar	RI
有三个隆起的连接片，左旋	传动链节	带隆起的传动链节	锯链类型	成卷锯链	成卷锯链长度	圆锉直径	锉架、圆锉	PRC
돌출부로 구성된 연결 고리, 왼손잡이	구동 링크	돌출부로 구성된 구동 링크	체인 유형	체인 롤	체인 롤 길이	원형 줄 직경	원형 줄 포함 줄 홀더	ROK

						
(D)	Ematic-Führungsschiene ROLLOMATIC E (Standard)	Ematic-Führungsschiene ROLLOMATIC ES (Super)	Ematic-Führungsschiene ROLLOMATIC ES LIGHT	Ematic-Führungsschiene ROLLOMATIC E LIGHT	Ematic-Führungsschiene DUROMATIC	Ematic-Führungsschiene CARVING E
(GB)	Ematic guide bar ROLLOMATIC E (Standard)	Ematic guide bar ROLLOMATIC ES (Super)	Ematic guide bar ROLLOMATIC ES LIGHT (Super)	EMATIC guide bar ROLLOMATIC LIGHT	EMATIC guide bar DUROMATIC	Ematic guide bar CARVING E
(F)	Guide-chaîne Ematic ROLLOMATIC E (Standard)	Guide-chaîne Ematic ROLLOMATIC ES (Super)	Guide-chaîne Ematic ROLLOMATIC ES LIGHT (Super)	Guide-chaîne Ematic ROLLOMATIC E LIGHT	Guide-chaîne Ematic DUROMATIC	Guide-chaîne Ematic CARVING E
(E)	Espada Ematic ROLLOMATIC E (Standard)	Espada Ematic ROLLOMATIC ES (Super)	Espada Ematic ROLLOMATIC ES LIGHT (Super)	Espada Ematic ROLLOMATIC E LIGHT	Espada Ematic DUROMATIC	Espada Ematic CARVING E
(P)	Guia Ematic ROLLOMATIC E (standard)	Guia Ematic ROLLOMATIC ES (Super)	Guia Ematic ROLLOMATIC ES LIGHT (Super)	Guia Ematic ROLLOMATIC E LIGHT	Guia Ematic DUROMATIC	Guia Ematic CARVING E
(I)	Spranga di guida Ematic ROLLOMATIC E (Standard)	Spranga di guida Ematic ROLLOMATIC ES (Super)	Spranga di guida Ematic ROLLOMATIC ES LIGHT (Super)	Spranga di guida Ematic ROLLOMATIC E LIGHT	Spranga di guida Ematic DUROMATIC	Spranga di guida Ematic CARVING E
(NL)	Ematic-zaagblad ROLLOMATIC E (standaard)	Ematic-zaagblad ROLLOMATIC ES (super)	Ematic-zaagblad ROLLOMATIC ES LIGHT (super)	Ematic-zaagblad ROLLOMATIC E LIGHT	Ematic-zaagblad DUROMATIC	Ematic-zaagblad CARVING E
(S)	Ematic-svärd ROLLOMATIC E (Standard)	Ematic-svärd ROLLOMATIC ES (Super)	Ematic-svärd ROLLOMATIC ES LIGHT (Super)	EMATIC-SVÄRD ROLLOMATIC E LIGHT	EMATIC-SVÄRD DUROMATIC	Ematic-svärd CARVING E
(N)	Ematic-sverd ROLLOMATIC E (standard)	Ematic-sverd ROLLOMATIC ES (super)	Ematic-sverd ROLLOMATIC ES LIGHT (super)	EMATIC-SVERD ROLLOMATIC E LIGHT	EMATIC-SVERD DUROMATIC	Ematic-sverd CARVING E
(FIN)	Ematic-terälevy ROLLOMATIC E (vakio)	Ematic-terälevy ROLLOMATIC ES (super)	Ematic-terälevy ROLLOMATIC ES LIGHT (super)	EMATIC-TERÄLEVY ROLLOMATIC E LIGHT	EMATIC-TERÄLEVY DUROMATIC	Ematic-terälevy CARVING E
(DK)	Ematic-sværd ROLLOMATIC E (Standard)	Ematic-sværd ROLLOMATIC ES (Super)	Ematic-sværd ROLLOMATIC ES LIGHT (Super)	EMATIC-SVÆRD ROLLOMATIC E LIGHT	EMATIC-SVÆRD DUROMATIC	Ematic-sværd CARVING E
(GR)	Λάμες Ematic ROLLOMATIC E (Standard)	Λάμες Ematic ROLLOMATIC ES (Super)	Λάμες Ematic ROLLOMATIC ES LIGHT (Super)	Λάμες Ematic ROLLOMATIC E LIGHT	Λάμες Ematic DUROMATIC	Λάμα CARVING E με σύστημα Ematic
(TR)	Ematic-Kılavuzu ROLLOMATIC E (Standard)	Ematic-Kılavuzu ROLLOMATIC ES (Super)	Ematic-Kılavuzu ROLLOMATIC ES LIGHT (Super)	Ematic-Kılavuzu ROLLOMATIC E LIGHT	Ematic-Kılavuzu DUROMATIC	Ematic-Kılavuzu CARVING E
(HR)	Ematic-vodilica ROLLOMATIC E (Standard)	Ematic-vodilica ROLLOMATIC ES (Super)	Ematic-vodilica ROLLOMATIC ES LIGHT (Super)	Ematic-vodilica ROLLOMATIC E LIGHT	Ematic-vodilica DUROMATIC	Ematic-vodilica CARVING E

								
Nutbreite	Umlenkstern Zähnezahl	Umlenkstern/ Schienenkopf	Senkniet	Satz Verschluss- glied	Höckertreibglied (3/8")	Höckertreibglied (3/8") kurz		
Groove width	Sprocket nose, number of teeth	Sprocket nose, bar button	Countersunk rivet	Twist lock link kit	Humped drive link (3/8")	Humped drive link (3/8") short		
Jauge (largeur de rainure)	Nombre de dents pignon de renvoi	Pignon de renvoi / tête de guide-chaîne	Rivet à tête noyée	Jeu de pièces joint de chaîne	Maillon d'entraîne- ment à bossage(s) (3/8")	Maillon d'entraîne- ment à bossage(s) (3/8") court		
Ancho de ranura	Número de dientes de la estrella de reenvío	Estrella de reenvío/punta de la espada	Remache avellanado	Juego eslabón de cierre	Eslabón impulsor de corcova (3/8")	Eslabón impulsor de corcova (3/8") corto		
Largura da ranhura	Estrela de retorno Número de dentes	Estrela de retorno/Cabeça da guia	Rebite de embutir	Jogo Elo roscado	Elo de accionamento com saliências (3/8")	Elo de accionamento com saliências (3/8") curto		
Larghezza della scanalatura	Stella di rinvio/ numero dei denti	Stella di rinvio/ testata spranga	Rivetto a testa svasata	Serie maglia di chiusura	Maglia di guida a gobba (3/8")	Maglia di guida a gobba (3/8") corta		
Groefbreedte	Neustandwiel aantal tanden	Neustandwiel/ zaagbladneus	Klinknagel met verzonken kop	Sluitschakelset	Knobbel- aandrijfschakel (3/8")	Knobbel- aandrijfschakel (3/8") kort		
Spårbredd	Topprissa kuggantal	Topprissa/ svärdhuvud	Försänkt nit	Sats låslänk	Drivlänk med puckel (3/8")	Drivlänk med puckel (3/8") kort		
Sporbredde	Returstjerne tannantall	Returstjerne/ skinnhode	Nagle med forsenket hode	Sett lukningsledd	Forhøynings- drivledd (3/8")	Forhøynings- drivledd (3/8") kort		
Uraleveys	Kärkipyörä, hammasluku	Kärkipyörä / terälevyn kärki	Upponiitti	Liitoslenkkisarja	Huipullinen vetolenkki (3/8")	Huipullinen vetolenkki (3/8"), lyhyt		
Notbredde	Styrestjerne tand-tal	Styrestjerne/ Sværdhoved	Forsænket nitte	Lukkeledsæt	Höcker-drivled (3/8")	Höcker-drivled (3/8") kort		
Πλάτος αυλακιού	Αριθμός δοντιών γραναζιού μύτης	Γρανάζι μύτης / Μύτη λάμας	Χωνευτό πριτσίνι	Σετ κλειδαριάς	Οδηγός με εξογκώματα (3/8")	Οδηγός με εξογκώματα (3/8") κοντός		
Yiv genişliği	Yönlendirici yıldızın diş sayısı	Yönlendirici yıldız / Kılavuzun ucu	Gömme başlı perçin	Kilit baklası seti	Tepeli tahrik baklası (3/8inç)	Tepeli tahrik baklası (3/8inç) kısa		
Širina utora	Škretna zvijezda, broj zuba	Škretna zvijezda/ glava vodilice	Upusna zakovica	Garnitura zapornih karika	Grbava pogonska karika (3/8")	Grbava pogonska karika (3/8") kurz		

						
(SLO)	Meč Ematic ROLLOMATIC E (Standard)	Meč Ematic ROLLOMATIC ES (Super)	Meč Ematic ROLLOMATIC ES LIGHT (Super)	Meč Ematic ROLLOMATIC LIGHT	Meč Ematic DUROMATIC	Meč Ematic CARVING E
(SRB)	Ematic-vodilica ROLLOMATIC E (Standard)	Ematic-vodilica ROLLOMATIC ES (Super)	Ematic-vodilica ROLLOMATIC ES LIGHT (Super)	Ematic-vodilica ROLLOMATIC LIGHT	Ematic-vodilica DUROMATIC	Ematic-vodilica CARVING E
(CZ)	Vodící lišta ROLLOMATIC E (Standard)	Vodící lišta ROLLOMATIC ES (Super)	Vodící lišta ROLLOMATIC ES LIGHT (Super)	Vodící lišta ROLLOMATIC E LIGHT	Vodící lišta DUROMATIC	Vodící lišta CARVING E
(SK)	Vodiaca lišta Ematic ROLLOMATIC E (štandard)	Vodiaca lišta Ematic ROLLOMATIC ES (super)	Vodiaca lišta Ematic ROLLOMATIC ES LIGHT (super)	Vodiaca lišta Ematic ROLLOMATIC LIGHT	Vodiaca lišta Ematic DUROMATIC	Vodiaca lišta Ematic CARVING E
(H)	Ematic vezetőlemez ROLLOMATIC E (standard)	Ematic vezetőlemez ROLLOMATIC ES (Super)	Ematic vezetőlemez ROLLOMATIC ES LIGHT (Super)	Ematic vezetőlemez ROLLOMATIC LIGHT	Ematic vezetőlemez DUROMATIC	Ematic vezetőlemez CARVING E
(PL)	Prowadnica Ematic ROLLOMATIC E (Standard)	Prowadnica Ematic ROLLOMATIC ES (Super)	Prowadnica Ematic ROLLOMATIC ES LIGHT (Super)	Prowadnica Ematic ROLLOMATIC E LIGHT	Prowadnica Ematic DUROMATIC	Prowadnica Ematic CARVING E
(RUS)	Ematic-направляющая шина ROLLOMATIC E (Standard)	Ematic-направляющая шина ROLLOMATIC ES (Super)	Ematic-направляющая шина ROLLOMATIC ES LIGHT (Super)	Ematic-направляющая шина ROLLOMATIC E LIGHT	Ematic-направляющая шина DUROMATIC	Ematic-направляющая шина CARVING E
(BG)	Ematic ("ематична") шина тип ROLLOMATIC E (Стандарт/Standard)	Ematic ("ематична") шина тип ROLLOMATIC ES (Супер/Super)	Ematic ("ематична") шина тип ROLLOMATIC ES LIGHT (Супер/Super)	Ematic ("ематична") шина тип ROLLOMATIC E LIGHT	Ematic ("ематична") шина тип DUROMATIC	Ematic ("ематична") шина тип CARVING E
(RO)	Ematic șine port-lanț ROLLOMATIC E (standard)	Ematic șine port-lanț ROLLOMATIC ES (super)	Ematic șine port-lanț ROLLOMATIC ES LIGHT (super)	Ematic șine șine port-lanț ROLLOMATIC E LIGHT	Ematic șine șine port-lanț DUROMATIC	Ematic șine șine port-lanț CARVING E
(J)	E マチックガイドバーローロマチック E (標準)	E マチックガイドバーローロマチック ES (スーパー)	E マチックガイドバーローロマチック ES LIGHT (スーパー)	E マチックガイドバーローロマチック ライト	E マチックガイドバーデュロマチック	E マチックガイドバーカービング E
(RI)	Batang pengantar Ematic ROLLOMATIC E (Standard)	Batang pengantar Ematic ROLLOMATIC ES (Super)	Batang pengantar Ematic ROLLOMATIC ES LIGHT (Super)	Batang pengantar Ematic ROLLOMATIC E LIGHT	Batang pengantar Ematic DUROMATIC	Batang pengantar Ematic CARVING E
(PRC)	Ematic 导板 ROLLOMATIC E (标准型)	Ematic 导板 ROLLOMATIC ES (加强型)	Ematic 导板 ROLLOMATIC ES LIGHT (加强型)	Ematic 导板 ROLLOMATIC LIGHT	Ematic 导板 DUROMATIC	Ematic 导板 CARVING E
(ROK)	Ematic 안내판 ROLLOMATIC E(표준)	Ematic 안내판 ROLLOMATIC ES(슈퍼)	Ematic 안내판 ROLLOMATIC ES LIGHT (슈퍼)	Ematic 안내판 ROLLOMATIC LIGHT	Ematic 안내판 DUROMATIC	Ematic 안내판 CARVING E

							
Širina utora	Obračalnik, število zob	Obračalnik, glava meča	Kovica z ugreznjeno glavo	Komplet zaključnega člena	Grbasti pogonski člen (3/8")	Grbasti pogonski člen (3/8"), kratak	
Širina žleba	Skretna zvezda broj zubaca	Skretna zvezda glava vodilice	Upuštena zakovica	Set Spojna karika sa bravicom	Pogonska karika sa ispupčenjem (3/8")	Pogonska karika sa ispupčenjem (3/8") kratka	
Šírka drážky	Počet zubov vratnej hviezdy	Gombík lišty vratnej hviezdy	Zapustený nit	Súprava uzatváracích článkov	Vodiaci článok s výstupkami (3/8")	Vodiaci článok s výstupkami (3/8") krátky	
Šírka drážky	Počet zubov vratnej hviezdy	Gombík lišty vratnej hviezdy	Zapustený nit	Súprava uzatváracích článkov	Vodiaci článok s výstupkami (3/8")	Vodiaci článok s výstupkami (3/8") krátky	
Horonyszéleség	A láncvezető fogszáma	Láncvezető, vezetőlemez-gomb	Süllyesztett fejű szegecs	Zárószem-készlet	Bütykös vezetőszem (3/8")	Bütykös vezetőszem (3/8") rövid	
Szerokość rowka prowadnicy	Liczba zębów kółka gwiazdkowego	Kółko gwiazdkowe/wierzchołek prowadnicy	Nit zagłębiany	Zestaw ogniwa spinającego	Wygarbione ogniwo napędowe (3/8")	Wygarbione ogniwo napędowe (3/8") krótkie	
Ширина паза	Ведомая звездочка Число зубьев	Ведомая звездочка/ Головка шины	Заклёпка с потайной головкой	Набор замковых звеньев	Выступающее ведущее звено (3/8")	Выступающее ведущее звено (3/8") короткое	
Широчина на канала	Звездочка – брой на зъбите	Звездочка / глава на шината	Нит със скрита глава	Комплект заключващи звена	Водещо звено с "Гърбица" (3/8")	Водещо звено с "Гърбица" (3/8") късо	
Lățimea canelurii	Pinion număr dinți	Pinion / cap șine	Nit cu cap înecat	Set element de închidere	Element de antrenare bosaj (3/8")	Element de antrenare bosaj (3/8") scurt	
溝幅	スプロケット ノーズ (歯数)	スプロケット ノーズ (パー ボタン)	皿頭リベット	ツイスト ロック リンク キット	こぶ付きドライブ リンク (3/8")	こぶ付きドライブ リンク (3/8") 短	
Lebar alur	Jumlah gigi sproket ujung	Sproket ujung/ bagian kepala	Rivet countersink	Set mata pengunci rantai	Mata penggerak rantai jenis hump (3/8")	Mata penggerak rantai jenis hump (3/8") pendek	
导槽宽度	链轮端部，齿数	链轮端部，导板头	埋头铆钉	连接片套件	带隆起的传动链节 (3/8")	带隆起的传动链节 (3/8")，短型	
홈 너비	스프로켓 노즈형, 톱니 수	스프로켓 노즈형, 바 버튼	접시머리 리벳	잠금 링크 키트	돌출부 구동 링크(3/8")	짧은 돌출부 구동 링크(3/8")	

D STIHL Sägeketten und Führungsschienen



Dieser Katalog enthält eine Vielzahl von Kombinationen aus Motorsägen, Sägeketten und Führungsschienen. Ein Teil dieser Kombinationen ist ausschließlich für spezielle Anwendungen und besonders geschulte Anwender vorgesehen. Diese Kombinationen können beispielsweise ein erhöhtes Risiko durch Kickback¹⁾ und/oder durch kopflastige Balance²⁾ aufweisen. Für normale Anwendungen und Einsatzzwecke empfiehlt STIHL die Kombinationen, die in der Gebrauchsanleitung zum jeweiligen Produkt genannt sind.

- 1) Bei einem Rückschlag (Kickback) wird die Säge plötzlich und unkontrollierbar zum Benutzer geschleudert. Ein Rückschlag kann zu tödlichen Schnittverletzungen führen.
- 2) Längere Führungsschienen verschieben den Schwerpunkt in Richtung Schienenspitze (veränderte Balance), so dass die Motorsäge dazu neigt mit der Schienenspitze nach unten zu kippen.

GB STIHL saw chains and guide bars



This catalog contains numerous combinations of chain saws, saw chains and guide bars. Some of these combinations are intended solely for special applications and specially trained users. These combinations may for example mean increased risk due to kickback¹⁾ and/or top-heavy balance²⁾. For normal applications and intended use, STIHL recommends using the combinations specified in the instruction manual for the corresponding product.

- 1) Kickback occurs when the chain saw is suddenly thrown up and back in an uncontrolled arc towards the operator. Kickback may result in serious or fatal injury.
- 2) Longer guide bars shift the center of gravity toward the tip of the bar (change in balance), so that chain saw tends to tip downward with the tip of the bar first.

F Chaînes et guide-chaînes STIHL



Ce catalogue renferme une multitude de combinaisons de tronçonneuses, de chaînes et de guide-chaînes. Certaines combinaisons sont exclusivement réservées à des utilisations spéciales et à des utilisateurs dotés d'une formation particulière. De telles combinaisons peuvent par ex. présenter un plus grand risque de rebond (kick-back)¹⁾ et/ou un risque dû à la position plus avancée du centre de gravité²⁾. Pour les travaux ordinaires, dans des conditions normales, STIHL recommande d'utiliser les combinaisons indiquées dans la notice d'emploi de la machine respective.

- 1) En cas de rebond (kick-back), la tronçonneuse est brusquement projetée en direction de l'utilisateur en décrivant un mouvement incontrôlable. Un rebond peut causer des coupures mortelles.
- 2) L'utilisation de guide-chaînes plus longs se traduit par un déplacement du centre de gravité en direction du nez du guide-chaîne (déséquilibre de la machine), c'est-à-dire que le nez du guide-chaîne a tendance à s'abaisser et à faire basculer la machine.

E Cadenas y espadas STIHL



Este catálogo contiene gran cantidad de combinaciones de motosierras, cadenas y espadas. Una parte de estas combinaciones está prevista exclusivamente para aplicaciones especiales y usuarios especialmente instruidos. Estas combinaciones pueden presentar por ejemplo un riesgo elevado por rebote¹⁾ y/o por un balance pesado en la parte delantera²⁾. Para aplicaciones y tareas normales, STIHL recomienda las combinaciones que se nombran en el manual de instrucciones del respectivo producto.

- 1) Al producirse un rebote (kickback), la motosierra es lanzada repentinamente y de forma incontrolable hacia el operario. Un rebote puede ocasionar lesiones de cortes mortales.
- 2) Las espadas más largas desplazan el centro de gravedad hacia la punta de la espada (balance modificado), de manera que la motosierra tiene tendencia a volcar hacia delante por la punta de la espada.

P Correntes e guias da STIHL



Este catálogo contém uma multiplicidade de combinações de moto-serras, correntes e guias. Uma parte destas combinações está prevista exclusivamente para utilizações especiais e utilizadores com uma formação particular. Estas combinações podem apresentar por exemplo um maior risco pelo kickback¹⁾ e/ou pelo balanço pesado de proa²⁾. A STIHL recomenda as combinações mencionadas nas Instruções de serviço referentes ao produto respectivo para utilizações e finalidades de emprego normais

- 1) A moto-serra é lançada repentina e incontrolavelmente em direcção do utilizador no caso de um rebate (kickback). Um rebate pode conduzir a feridas mortais causadas pelo corte.
- 2) Guias mais compridas mudam o ponto de gravidade em direcção da ponta da guia (balanço modificado) de modo que a moto-serra tenha a tendência de bascular com a ponta da guia para baixo.

① Catene e spranghe di guida STIHL



Il presente catalogo presenta numerose combinazioni fra motoseghe, catene e spranghe di guida. Una parte di queste combinazioni è destinata esclusivamente ad impieghi speciali e operatori appositamente istruiti. Queste combinazioni possono comportare per esempio un elevato rischio causato dal Kickback¹⁾ e/o l'equilibrio concentrato sulla testa²⁾.

Per le applicazioni e gli impieghi normali, STIHL consiglia le combinazioni riportate nelle Istruzioni d'uso del rispettivo prodotto.

- 1) Nel rimbalzo (kickback) la motosega viene proiettata improvvisamente e in modo incontrollabile verso l'operatore. Il rimbalzo può causare ferite da taglio mortali.
- 2) Le spranghe più lunghe spostano il baricentro verso la punta della spranga (equilibrio variato), di modo che la motosega tende di ribaltarsi in basso con la punta della spranga.

Ⓝ STIHL zaagkettingen en zaagbladen



In deze catalogus staat een groot aantal combinaties van motorzagen, zaagkettingen en zaagbladen. Een deel van deze combinaties is uitsluitend bedoeld voor speciale toepassingen en speciaal geschoolde gebruikers. Deze combinaties kunnen bijvoorbeeld een verhoogd risico op kick back¹⁾ en/of neuslastige balans²⁾ vertonen. Voor normale toepassingen en werkzaamheden adviseert STIHL de combinaties die in de handleiding van het betreffende product staan vermeld.

- 1) Bij terugslag (kick back) wordt de motorzaag plotseling en oncontroleerbaar in de richting van de gebruiker geslingerd. Een terugslag kan tot dodelijk letsel leiden.
- 2) Bij langere zaagbladen verschuift het zwaartepunt naar de zaagbladneus (gewijzigde balans), zodat de motorzaag de neiging heeft met de zaagbladneus naar beneden te kantelen.

⑤ STIHL Sågkedjor och svärd



Denna katalog innehåller ett flertal kombinationer av motorsågar, sågkedjor och svärd. En del av dessa kombinationer är enbart avsedda för speciella användningsområden och användare med särskild utbildning. Sådana kombinationer kan exempelvis öka risken för kast (s.k. kickback)¹⁾ och/eller obalans p.g.a. tung svärdsspets²⁾. För normal användning och normalt ändamål rekommenderar STIHL kombinationerna som anges i bruksanvisningen till den aktuella produkten.

- 1) Vid kast (kickback) slungas motorsågen plötsligt och okontrollerat mot användaren. Ett kast kan orsaka dödliga skärskador.
- 2) Längre svärd förskjuter tyngdpunkten mot svärdsspetsen (ändrad balans), så att motorsågen tenderar att luta med svärdsspetsen nedåt.

Ⓝ STIHL sagkjeder og sverd



Denne katalog inneholder mangfoldige kombinasjoner av motorsager, sagkjeder og sverd. En del av disse kombinasjonene er kun tiltenkt spesielle bruksområder og spesielt opplærte brukere. Disse kombinasjonene kan for eksempel oppvise økt risiko grunnet kast¹⁾ og/eller balanse med tyngdepunkt øverst²⁾. For normal bruk og til vanlige bruksforhold anbefaler STIHL kombinasjonene som står oppført i bruksanvisningene for de enkelte produktene.

- 1) Ved kast (kickback) slynges sagen plutselig og ukontrollert mot brukeren. Slike kast kan gi dødelige kuttskader.
- 2) Lengre sverd forskyver tyngdepunktet mot sverdspissen (endret balanse), slik at motorsagen har en tendens til å tippe med sverdspissen nedover.

Ⓝ STIHL teräketjut ja terälevyt



Tässä luettelossa on monia moottorisahojen, terälevyjen ja teräketjujen teknisiä yhdistelmiä. Osa yhdistelmistä on tarkoitettu vain erityiskäyttöön ja erityiskoulutuksen saaneille käyttäjille. Näihin yhdistelmiin saattaa liittyä tavallista suurempi vaara takapotkun¹⁾ ja/tai kärkipainotteisuuden²⁾ vuoksi. Tavanomaiseen käyttöön soveltuvat STIHLin suosittellamat yhdistelmät ovat laitteesi käyttöohjeessa.

- 1) Takapotkussa moottorisaha kimpoaa hallitsemattomasti kohti käyttäjää. Takapotku voi johtaa hengenvaarallisiin viiltohaavoihin.
- 2) Pitkän terälevyn painopiste on lähempänä terälevyn kärkeä (tasapaino muuttunut), niin että moottorisaha pyrkii painamaan terälevyn kärjen alas.

DK TIHL savkæder og sværd



Dette katalog indeholder mange kombinationer af motorsave, savkæder og sværd. En del af disse kombinationer er udelukkende tiltænkt specielle anvendelser og særligt uddannede brugere. Kombinationerne kan eksempelvis udgøre en øget risiko som følge af kickback¹⁾ og/eller næsetung balance²⁾. Til normale anvendelser og brugsformål anbefaler STIHL kombinationerne, som er nævnt i betjeningsvejledningen til det pågældende produkt.

- 1) Ved et tilbageslag (kickback) bliver motorsaven pludseligt og ukontrolleret slynget tilbage mod brugeren. Et tilbageslag kan medføre livsfarlige snitsår.
- 2) Længere sværd forskyder tyngdepunktet i retning mod sværdspidsen (ændret balance), så motorsaven har tilbøjelighed til at tippe nedad med sværdspidsen.

GR Αλυσίδες και λάμες STIHL



Αυτός ο κατάλογος περιέχει ένα πλήθος συνδυασμών από αλυσοπρίονα, λάμες και αλυσίδες. Ορισμένοι από αυτούς τους συνδυασμούς προορίζονται αποκλειστικά για ειδικές εφαρμογές και για χρήστες με ειδική εκπαίδευση. Τέτοιοι συνδυασμοί μπορεί π.χ. να παρουσιάζουν υψηλό κίνδυνο λόγω κλοστήματος¹⁾ ή/και λόγω άνισης κατανομής του βάρους²⁾. Για κανονική χρήση, η STIHL συνιστά τους συνδυασμούς που αναφέρονται στις οδηγίες χρήσης του εκάστοτε προϊόντος.

- 1) Σε περίπτωση κλοστήματος (σκορτσάρισμα), το αλυσοπρίονο τινάσσεται ξαφνικά και ανεξέλεγκτα προς τον χειριστή. Το κλότσημα μπορεί να προκαλέσει θανατηφόρους τραυματισμούς.
- 2) Οι μεγάλες λάμες μετατοπίζουν το κέντρο βάρους προς τη μύτη της λάμας (μεταβολή της ισορροπίας), με αποτέλεσμα το αλυσοπρίονο να «πέφτει» προς τα εμπρός.

TR STIHL testereleri ve kılavuzları



Bu katalogta motorlu testerelerin, zincirlerin ve kılavuzların birbirleriyle kombine imkanlarını göreceksiniz. Bu kombinasyonların bir kısmı istisnasız özel eğitimli kullanıcıların özel kullanım alanları için ön görülmüştür. Bu kombinasyonların örneğin yüksek bir geri tepme¹⁾ (Kickback) riski ve/veya aletin ucunu ağırlaştırarak denge değişimi riski²⁾ bulunur. Normal kullanım alanları için STIHL firması her ürününün kendi kullanma talimatında öngörülen kombinasyonları kullanmanızı tavsiye eder.

- 1) Geri tepme olayında (kickback) motorlu testere birden kontrolsüzce kullanıcıya doğru fırlar. Geri tepme, ölümcül yaralanmalara yol açabilir.
- 2) Uzun kılavuzlarda ağırlık noktası kılavuz ucuna doğru kayar (denge değişimi), bundan dolayı motorlu testerenin ucu aşağıya doğru ağırlaşır düşmeye meyillendir.

HR Lanci pile i vodilice tvrtke STIHL



Ovaj katalog sadrži mnogobrojne kombinacije motornih pila, lanaca pile i vodilica. Jedan dio ovih kombinacija je predviđen isključivo za specijalne primjene i za posebno školovane korisnike/poslužitelje. Te kombinacije mogu primjerice imati povećan rizik uslijed Kickback-a¹⁾ i/ili uslijed Balance²⁾ koji opterećuje glavu. Za normalne uporabe i svrhe primjene tvrtka STIHL preporučuje kombinacije, koje su navedene u uputi za uporabu za dotični proizvod.

- 1) U slučaju povratnog udara (Kickback) se motorna pila iznenada i nekontrolirano zavrtloži-zavrtla prema korisniku/poslužitelju. Povratni udar može uzrokovati smrtonosne povrede pri rezanju.
- 2) Dulje vodilice pomiču težište u smjeru vrha vodilice (promijenjen balans) tako, da motorna pila pokazuje sklonost, da se s vrhom vodilice nagne/prekrene prema dolje.

SLO Verige in meči STIHL



Ta katalog vsebuje številne kombinacije motornih žag, verig in mečev. Nekatere izmed teh kombinacij so predvidene samo za posebne uporabe in posebej šolano osebje. Pri teh kombinacijah lahko pride na primer do povečanega tveganja zaradi povratnega udarca motorne žage¹⁾ in/ali zaradi prevesnega ravnotežja²⁾. Za običajno uporabo in namene uporabe STIHL priporoča kombinacije, ki so navedene v navodilih za uporabo posameznega izdelka

- 1) Pri povratnem udarcu (Kickback) žago naenkrat nenadzorovano zažene proti uporabniku. Povratni udarec lahko povzroči smrtne poškodbe.
- 2) Daljši meči premaknejo težišče v smeri konice meča (spremenjeno ravnotežje). Zato se konica meča motorne žage rada prevesi navzdol.

SRB STIHL rezni lanci i vodilice



Ovaj katalog sadrži razne kombinacije motornih testera, reznih lanaca i vodilica. Neke od tih kombinacija predviđene su isključivo za specijalne namene koje izvođe posebno obučeni opslužnici. Ove kombinacije, na primer, mogu da povećaju opasnost od povratnog udarca¹⁾ i/ili od težišta premeštenog ka vrhu²⁾. Kod normalne namene i načina upotrebe STIHL preporučuje da se koriste kombinacije koje su navedene u uputstvu za upotrebu datog uređaja.

- 1) Kod povratnog udarca (Kickback) motorna testera odjednom i nekontrolisano biva odbačena prema korisniku. Povratni udarac može dovesti do smrtonosnih posekotina.
- 2) Duže vodilice pomiču težište ka vrhu vodilice (promenjeno težište), tako da motorna testera ima tendenciju da pada vrhom vodilice na dole.

CZ Pilové řetězy a vodící lišty STIHL



Tento katalog obsahuje četné kombinace z motorových pil, pilových řetězů a vodících lišt. Část těchto kombinací je předurčena výlučně jen pro speciální práce a speciálně vyškolené uživatele. Tyto kombinace mohou například vykazovat zvýšené riziko zpětného rázu Kickback¹⁾ a/nebo převažování stroje²⁾ ke hrotu lišty. Pro běžné použití a účely práce doporučuje STIHL kombinace, které jsou uvedeny vždy v návodu k použití patřičného výrobku.

- 1) Při zpětném rázu (Kickback) dochází k náhlému a nekontrolovatelnému vyvržení motorové pily směrem k uživateli. Zpětný ráz může vést ke smrtelným řezným úrazům.
- 2) Delší vodící lišty posunují těžiště směrem ke hrotu lišty (pozměněná rovnováha) tak, že motorová pila má tendenci sklopit se hrotem lišty dolů.

SK Pílové reťaze a vodiace lišty STIHL



Tento katalóg obsahuje množstvo kombinácií z motorových pil, pílových reťazí a vodiacich lišt. Časť týchto kombinácií je určená výhradne na špeciálne aplikácie a pre osobitne vyškolených používateľov. Tieto kombinácie môžu predstavovať napríklad zvýšené riziko v dôsledku spätného rázu¹⁾ a/alebo v dôsledku rovnováhy so zaťažením prednej časti²⁾. Pre normálne použitia a účely použitia odporúča spoločnosť STIHL kombinácie, ktoré sú k príslušnému produktu uvedené v návode na použitie

- 1) Pri spätnom ráze (kickback) dochádza k náhlému a nekontrolovateľnému vyvršteniu motorovej pily smerom k používateľovi. Spätný ráz môže viesť k smrteľným poraneniám porezaním.
- 2) Dlhšie vodiace lišty presunú ťažisko v smere hrotu lišty (zmenená rovnováha) tak, že má motorová pila tendenciu sklopit'.

H STIHL fűrészláncok és vezetőlemezek



Ez a katalógus motorfűrészek, fűrészláncok és vezetőlemezek számos kombinációját tartalmazza. Ezek egy részét kizárólag speciális alkalmazásokhoz és különösen gyakorlott felhasználók számára irányozták elő. Ezek a kombinációk adott esetben fokozott kockázattal járhatnak a visszacsapódásból¹⁾ és / vagy a fejnéhöz egyensúlyi helyzetből²⁾ adódóan. A normál alkalmazásokhoz és felhasználási célokhoz a STIHL a mindenkorli termék használati utasításában megadott kombinációk használatát ajánlja

- 1) Visszacsapódás (Kickback) esetén a motorfűrész hirtelen és ellenőrizhetetlenül a berendezés kezelője felé csapódik. A visszalökés halálos vágási sérüléseket okozhat.
- 2) Hosszabb vezetőlemezek esetén a súlypont eltolódik a lemezcsúcs irányába (megváltozik az egyensúly), miáltal a motorfűrész hajlamos a lemezcsúccsal lefelé billenni.

PL Piły łańcuchowe i prowadnice STIHL



Katalog zawiera obszerną ofertę dostępnych kombinacji pilarek spalinowych, pił łańcuchowych i prowadnic. Część tej kombinacji jest przewidziana wyłącznie do zastosowań specjalnych i specjalnie przeszkolonego personelu. Kombinacje mogą się przykładowo wiązać z podwyższonym ryzykiem związanym z odrzucaniem wstecznym¹⁾ i/lub i przednim wyważeniem²⁾.

Do zwykłych zastosowań i prac STIHL zaleca kombinacje, które zostały podane w instrukcji użytkownika danego produktu.

- 1) Przy odrzuceniu wstecznym (kickback) pilarka spalinowa zostaje niespodziewanie i w niekontrolowany sposób odrzucona w kierunku użytkownika. Odrzucenie wsteczne może prowadzić do ciężkich uszkodzeń ciała ze skutkiem śmiertelnym.
- 2) Dłuższe szyny prowadzące powodują przesunięcie punktu ciężkości w kierunku końca szyny (zmienione wyważenie), przez co pilarka łańcuchowa ma tendencję do ciągnięcia w dół przy końcu szyny.

RUS Пильные цепи и направляющие шины STIHL



Данный каталог содержит в себе большое количество комбинаций бензопил, пильных цепей и направляющих шин. Часть данных комбинаций предусмотрена исключительно для специальных областей применения и для специально обученных пользователей. Данные комбинации могут, например, иметь повышенный риск из-за обратной отдачи¹⁾ и/или смещённого центра тяжести²⁾. Для обычного применения и обычных цепей применения фирма STIHL рекомендует комбинации, которые приведены в руководстве по применению для соответствующего продукта.

- 1) При обратной отдаче (Kickback) пила, выйдя из-под контроля, бесконтрольно отбрасывается в сторону пользователя. Обратная отдача может привести к смертельным резаным ранам.
- 2) Более длинные направляющие шины смещают центр тяжести в направлении верхушки шины (изменённый баланс) таким образом, что бензопила склонна к тому, чтобы опрокинута вершиной шины вниз.

BG Режещи вериги и шини STIHL



Този каталог съдържа многобройни комбинации от моторни триони, режещи вериги и шини. Част от тези комбинации е предвидена изключително за специализирано приложение, и то от специално обучени потребители. Тези комбинации биха могли например да представляват повишаване на рисковете при работа поради обратен удар¹⁾ ("кик-бек") и/или поради неустойчив утежен баланс²⁾. При нормално приложение и цели на използване STIHL препоръчва комбинациите, които са посочени в ръководството за употреба на съответното изделие.

- 1) При обратен удар (кик-бек) трионът отскача внезапно и неуправляемо към работещия с него. Обратният удар може да причини смъртоносни порезни наранявания.
- 2) По-дългите шини преместват центъра на тежестта в посока към върха на шината (променен баланс), така че моторният трион започва да показва тенденция да се преобърне надолу с върха на шината.

RO Lanțuri de fierăstrău și șine port-lanț STIHL



Acest catalog cuprinde o serie de combinații de motofierăstraie, lanțuri de fierăstrău și șine port-lanț. O parte a acestor combinații este destinată exclusiv unor aplicații speciale și utilizatorilor cu calificare specială. Aceste combinații pot avea un risc mărit cauzat de recul¹⁾ și/sau balansul²⁾ înspre capătul utilajului. Pentru utilizări și scopuri de aplicație normale, STIHL recomandă combinațiile specificate în instrucțiunile de utilizare ale fiecărui produs în parte.

- 1) În caz de recul (Kickback) fierăstrăul este aruncat brusc și incontrollabil înspre utilizator. Efectul de recul poate duce la răniri mortale.
- 2) Șinele port-lanț mai lungi translatează centrul de greutate înspre vârful șinei (modificarea balansului), astfel că motofierăstrăul tinde cu vârful șinei să se aplece în jos.

J STIHL ソーチェンとガイドバー



このカタログには、チェーンソー、ソーチェンおよびガイドバーの多数の組み合わせが記載されています。これらの組み合わせの一部は、特殊用途および特別に訓練を受けたユーザーのみを対象としています。これらの組み合わせのため、キックバック¹⁾が発生したりバランスが不安定²⁾になって、いくらかリスクが増大することがあります。通常の用途および通常の使用目的の場合、STIHL は当該製品の取扱説明書で指定されている組み合わせを使用することを推奨します。

- 1) キックバックとは、チェーンソーが、突然コントロールできない状態で作業者に向かって、跳ね返ってくることを言います。キックバックによって重度の外傷を受ける場合があります。
- 2) 長いガイドバーを使用すると、重心がバー先端にずれるため（バランスが変わる）、チェーンソーの先端が下がり、バーの先端が最初に当たるようになります。

RI Rantai gergaji dan batang pengantar STIHL



Katalog berikut berisi informasi tentang berbagai kombinasi dari gergaji mesin, rantai gergaji, dan batang pengantar. Sebagian dari kombinasi berikut hanya ditujukan untuk penggunaan tertentu dan pengguna yang dilatih secara khusus. Kombinasi berikut dapat menimbulkan, misalnya, risiko tinggi sentakan¹⁾ dan/atau keseimbangan yang berat di atas²⁾. Untuk penggunaan dan keperluan normal, STIHL menyarankan kombinasi yang telah dijelaskan dalam buku petunjuk pemakaian untuk setiap produk.

- 1) Jika terjadi sentakan (kickback), gergaji mesin akan berbalik secara tiba-tiba dan tidak terkontrol ke arah operator. Sentakan dapat menyebabkan cedera fatal karena terpotong.
- 2) Batang pengantar yang panjang akan menggeser titik gravitasi ke arah ujung batang pengantar (perubahan keseimbangan), sehingga gergaji mesin dan batang pengantar cenderung miring ke bawah.

PRC STIHL 鋸鏈和導板

本目录包含多种链锯、锯链和导板组合。部分组合仅适用于特殊应用场合或经过专门培训的用户。例如，反弹¹⁾和/或头部配重²⁾可能导致这些组合的危险性增加。对于正常应用和既定用途，STIHL 建议使用在说明书中为相应产品指定的组合。

- 1) 反弹会造成链锯以失控的弧度向操作者突然弹出或弹回。反弹可引发致命的切口。
- 2) 加长导板的重心移向导板端部（平衡发生变化），因此锯链倾向于先随导板端部向下倾斜。

ROK STIHL 기계톱 및 안내판

카탈로그에는 다양한 기계톱, 체인날 및 안내판을 체결하는 내용이 수록되어 있습니다. 이러한 조합 중 일부는 특수 분야와 특별 교육을 받은 사용자만이 사용할 수 있습니다. 예를 들어 이러한 조합은 반동¹⁾ 및/또는 상부의 무게에 의한 균형²⁾으로 인해 위험이 높아질 수 있습니다. 일반적인 응용 분야 및 용도와 관련하여 STIHL은 해당 제품의 사용 설명서에 명시된 조합을 사용할 것을 권장합니다.

- 1) 반동이 발생하면 기계톱이 예기치 못한 방향으로 사용자에게 튕겨옵니다. 반동으로 인해 치명적인 부상을 당할 수 있습니다.
- 2) 안내판이 길수록 사용할 경우 안내판 끝으로 무게 중심이 이동(균형이 변화함)하므로 기계톱이 안내판 끝 부분이 있는 아래쪽으로 기울어지게 됩니다.

mm in.	6,35 1/4" P		9,32 3/8" P		8,25 .325"		9,32 3/8"		10,26 .404"	
	1,1 .043	1,3 .050	1,1 .043	1,3 .050	1,3 .050	1,5 .058	1,6 .063	1,3 .050	1,5 .058	1,6 .063
RCK										
RCX										
RCXK										
RM		3660			3684	3685	3686	3650	3651	3652
RMS		3661								
RM3					3687	3688	3689	3662		3664
RMK										
RMF								3654		
RMX								3691	3692	3653
RS					3637	3638	3639	3623	3622	3621
RS3								3624		3626
RSK								3874		3898
RSF								3676	3677	3678
RD3								3681	3682	3683
RDR										3944
PM								3613		
PM3		3670						3636		
PMX								3614		
PMY								3615		
PMM3								3610		
PS								3617		
PS3								3616		
PD3								3612		

mm	in.	mm	mm
7	6,35 1/4 P	0,45	3,2
1	6,35 1/4	0,65	4,0
2	8,25 .325	0,65	4,8
6	9,32 3/8 P	0,65	4,0
3	9,32 3/8	0,65	5,2
	RD, RDR	0,65	-
4	10,26 .404	0,80	5,5

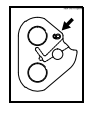
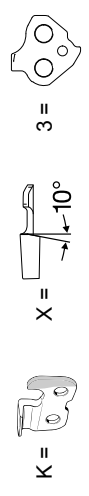

- 1 1,1 mm (.043 in.)
- 3 1,3 mm (.050 in.)
- 5 1,5 mm (.058 in.)
- 6 1,6 mm (.063 in.)
- 0 2,0 mm (.080 in.)

RAPID

PGCO

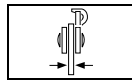
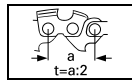
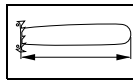

cm in. mm in. mm in.

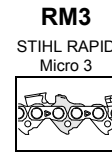

STIHL 009, 010, 011, 012 (011, 012)	30	12	9,32	3/8 P	1,3	.050					
	35	14	9,32	3/8 P	1,3	.050					
	40	16	9,32	3/8 P	1,3	.050					
	45	18	9,32	3/8 P	1,3	.050					
	(009)	25	10	9,32	3/8 P	1,1	.043				
	(009)	30	12	9,32	3/8 P	1,1	.043				
	(009)	35	14	9,32	3/8 P	1,1	.043				
	(009)	40	16	9,32	3/8 P	1,1	.043				
		25	10	6,35	1/4	1,3	.050	3661 000 0056	3660 000 0056		
		30	12	6,35	1/4	1,3	.050	3661 000 0064	3660 000 0064		
	35	14	6,35	1/4	1,3	.050		3660 000 0072			
	40	16	6,35	1/4	1,3	.050		3660 000 0080			
	35	14	8,25	.325	1,5	.058		3685 000 0056	3688 000 0056	3638 000 0056	
	35	14	8,25	.325	1,6	.063		3686 000 0056	3689 000 0056	3639 000 0056	
	40	16	8,25	.325	1,6	.063		3686 000 0062	3689 000 0062	3639 000 0062	
	45	18	8,25	.325	1,6	.063		3686 000 0068	3689 000 0068	3639 000 0068	
STIHL MS 150, MS 150 T	25	10	6,35	1/4 P	1,1	.043					
	30	12	6,35	1/4 P	1,1	.043					
	25	10	9,32	3/8 P	1,1	.043					
	30	12	9,32	3/8 P	1,1	.043					
	35	14	9,32	3/8 P	1,1	.043					
STIHL 017, 018, MS 170, MS 171, MS 180, MS 181, MS 192 C, MS 193 C	25	10	9,32	3/8 P	1,1	.043					
	30	12	9,32	3/8 P	1,1	.043					
	35	14	9,32	3/8 P	1,1	.043					
	40	16	9,32	3/8 P	1,1	.043					
	30	12	9,32	3/8 P	1,3	.050					
	35	14	9,32	3/8 P	1,3	.050					
	40	16	9,32	3/8 P	1,3	.050					
	25	10	6,35	1/4	1,3	.050	3661 000 0056	3660 000 0056			
	30	12	6,35	1/4	1,3	.050	3661 000 0064	3660 000 0064			
STIHL 019 T, MS 190 T, MS 192 T, MS 193 T	25	10	9,32	3/8 P	1,1	.043					
	30	12	9,32	3/8 P	1,1	.043					
	35	14	9,32	3/8 P	1,1	.043					
	40	16	9,32	3/8 P	1,1	.043					
	30	12	9,32	3/8 P	1,3	.050					
	35	14	9,32	3/8 P	1,3	.050					
	40	16	9,32	3/8 P	1,3	.050					
		25	10	6,35	1/4	1,3	.050	3661 000 0056			
		30	12	6,35	1/4	1,3	.050	3661 000 0064			
	MS 192 T, MS 193 T	25	10	6,35	1/4 P	1,1	.043				
	30	12	6,35	1/4 P	1,1	.043					
	35	14	6,35	1/4 P	1,1	.043					
STIHL 020 (1129), MS 200, MS 201, MS 201 C	30	12	9,32	3/8 P	1,3	.050					
	35	14	9,32	3/8 P	1,3	.050					
	40	16	9,32	3/8 P	1,3	.050					
	45	18	9,32	3/8 P	1,3	.050					
		25	10	6,35	1/4	1,3	.050	3661 000 0056	3660 000 0056		
		30	12	6,35	1/4	1,3	.050	3661 000 0064	3660 000 0064		
		35	14	6,35	1/4	1,3	.050		3660 000 0072		
		40	16	6,35	1/4	1,3	.050		3660 000 0080		

RD3
STIHL RAPID
Duro 3

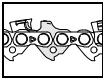

PS
STIHL PICCO
Super



PS3
STIHL PICCO
Super 3

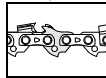

PM
STIHL PICCO
Micro



PM3
STIHL PICCO
Micro 3

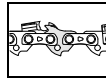

PD3
STIHL PICCO
Duro 3

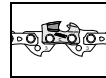

PMM3
STIHL PICCO
Micro Mini 3

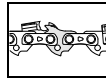

3617 000 0044	3616 000 0044	3613 000 0044	3636 000 0044	3612 000 0044
3617 000 0050	3616 000 0050	3613 000 0050	3636 000 0050	3612 000 0050
3617 000 0055	3616 000 0055	3613 000 0055	3636 000 0055	3612 000 0055
3617 000 0061	3616 000 0061	3613 000 0061	3636 000 0061	3612 000 0061

3610 000 0039
3610 000 0044
3610 000 0050
3610 000 0055

3666 000 0056

3667 000 0056
3667 000 0062
3667 000 0068

3670 000 0056
3670 000 0064

3610 000 0039
3610 000 0044
3610 000 0050

3610 000 0039
3610 000 0044
3610 000 0050
3610 000 0055

3617 000 0044	3616 000 0044	3613 000 0044	3636 000 0044	3612 000 0044
3617 000 0050	3616 000 0050	3613 000 0050	3636 000 0050	3612 000 0050
3617 000 0055	3616 000 0055	3613 000 0055	3636 000 0055	3612 000 0055

3610 000 0039
3610 000 0044
3610 000 0050
3610 000 0055

3616 000 0044	3636 000 0044	3612 000 0044
3616 000 0050	3636 000 0050	3612 000 0050
3616 000 0055	3636 000 0055	3612 000 0055

3670 000 0056
3670 000 0064
3670 000 0072

3617 000 0044	3616 000 0044	3613 000 0044	3636 000 0044	3612 000 0044
3617 000 0050	3616 000 0050	3613 000 0050	3636 000 0050	3612 000 0050
3617 000 0055	3616 000 0055	3613 000 0055	3636 000 0055	3612 000 0055
3617 000 0061	3616 000 0061	3613 000 0061	3636 000 0061	3612 000 0061

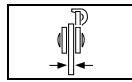
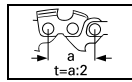
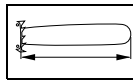

cm in. mm in. mm in.

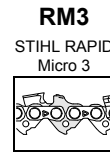

STIHL 020 T,	30	12	9,32	3/8 P	1,3	.050				
MS 200 T,	35	14	9,32	3/8 P	1,3	.050				
MS 201 T	40	16	9,32	3/8 P	1,3	.050				
MS 201 TC	45	18	9,32	3/8 P	1,3	.050				
(020 T,	25	10	6,35	1/4	1,3	.050	3661 000 0056			
MS 200 T)	30	12	6,35	1/4	1,3	.050	3661 000 0064			
STIHL 021, 023, 025,	30	12	9,32	3/8 P	1,3	.050				
MS 210,	35	14	9,32	3/8 P	1,3	.050				
MS 211,	40	16	9,32	3/8 P	1,3	.050				
MS 230,	45	18	9,32	3/8 P	1,3	.050				
MS 231,										
MS 241 C,	35	14	9,32	3/8 P	1,3	.050				
MS 250,	40	16	9,32	3/8 P	1,3	.050				
MS 251	45	18	9,32	3/8 P	1,3	.050				
	25	10	6,35	1/4	1,3	.050	3661 000 0056	3660 000 0056		
	30	12	6,35	1/4	1,3	.050	3661 000 0064	3660 000 0064		
	35	14	6,35	1/4	1,3	.050		3660 000 0072		
	40	16	6,35	1/4	1,3	.050		3660 000 0080		
	35	14	8,25	.325	1,5	.058		3685 000 0056	3688 000 0056	3638 000 0056
	35	14	8,25	.325	1,6	.063		3686 000 0056	3689 000 0056	3639 000 0056
	40	16	8,25	.325	1,6	.063		3686 000 0062	3689 000 0062	3639 000 0062
(025, MS 250)	45	18	8,25	.325	1,6	.063		3686 000 0068	3689 000 0068	3639 000 0068
	50	20	8,25	.325	1,6	.063		3686 000 0076	3689 000 0076	3639 000 0076
(023 L)	25	10	9,32	3/8 P	1,1	.043				
(023 L)	30	12	9,32	3/8 P	1,1	.043				
(023 L)	35	14	9,32	3/8 P	1,1	.043				
(023 L)	40	16	9,32	3/8 P	1,1	.043				
(025, MS 250)	45	18	9,32	3/8 P	1,3	.050				
STIHL 024, MS 240,	32	13	8,25	.325	1,5	.058		3685 000 0056	3688 000 0056	3638 000 0056
	37	15	8,25	.325	1,5	.058		3685 000 0062	3688 000 0062	3638 000 0062
	32	13	8,25	.325	1,6	.063		3686 000 0056	3689 000 0056	3639 000 0056
	37	15	8,25	.325	1,6	.063		3686 000 0062	3689 000 0062	3639 000 0062
	40	16	8,25	.325	1,6	.063		3686 000 0067	3689 000 0067	3639 000 0067
	45	18	8,25	.325	1,6	.063		3686 000 0074	3689 000 0074	3639 000 0074
	32	13	9,32	3/8 P	1,3	.050				
	40	16	9,32	3/8 P	1,3	.050				
	45	18	9,32	3/8 P	1,3	.050				

RD3
STIHL RAPID
Duro 3

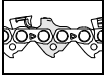

PS
STIHL PICCO
Super



PS3
STIHL PICCO
Super 3

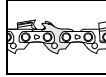

PM
STIHL PICCO
Micro



PM3
STIHL PICCO
Micro 3

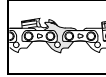

PD3
STIHL PICCO
Duro 3

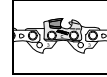

PMM3
STIHL PICCO
Micro Mini 3

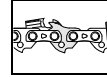

	3616 000 0044		3636 000 0044	3612 000 0044
	3616 000 0050		3636 000 0050	3612 000 0050
	3616 000 0055		3636 000 0055	3612 000 0055
	3616 000 0061		3636 000 0061	3612 000 0061

3617 000 0044	3616 000 0044	3613 000 0044	3636 000 0044	3612 000 0044
3617 000 0050	3616 000 0050	3613 000 0050	3636 000 0050	3612 000 0050
3617 000 0055	3616 000 0055	3613 000 0055	3636 000 0055	3612 000 0055
3617 000 0061	3616 000 0061	3613 000 0061	3636 000 0061	3612 000 0061

3617 000 0051 ¹	3616 000 0051 ¹	3613 000 0051 ¹	3636 000 0051 ¹	3612 000 0051 ¹
3617 000 0056 ¹	3616 000 0056 ¹	3613 000 0056 ¹	3636 000 0056 ¹	3612 000 0056 ¹
3617 000 0062 ¹	3616 000 0062 ¹	3613 000 0062 ¹	3636 000 0062 ¹	3612 000 0062 ¹

3666 000 0056

3667 000 0056
3667 000 0062
3667 000 0068

3610 000 0039
3610 000 0044
3610 000 0050
3610 000 0055

3617 000 0061 3616 000 0061 3613 000 0061 3636 000 0061 3612 000 0061

3666 000 0056
3666 000 0062

3667 000 0056
3667 000 0062
3667 000 0067
3667 000 0074

3613 000 0050	3636 000 0050	3612 000 0050
3613 000 0060	3636 000 0060	3612 000 0060
3613 000 0066	3636 000 0066	3612 000 0066

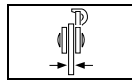
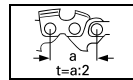
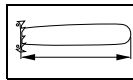

RM STIHL RAPID Micro



RM3 STIHL RAPID Micro 3

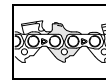

RS STIHL RAPID Super



RS3 STIHL RAPID Super 3

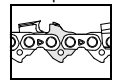

STIHL	Model	cm	in.	mm	in.	mm	in.	RM	RM3	RS	RS3		
STIHL	026, MS 260, MS 261, MS 261 C	32	13	8,25	.325	1,5	.058	3685 000 0056	3688 000 0056	3638 000 0056			
		37	15	8,25	.325	1,5	.058	3685 000 0062	3688 000 0062	3638 000 0062			
		32	13	8,25	.325	1,6	.063	3686 000 0056	3689 000 0056	3639 000 0056			
		37	15	8,25	.325	1,6	.063	3686 000 0062	3689 000 0062	3639 000 0062			
		40	16	8,25	.325	1,6	.063	3686 000 0067	3689 000 0067	3639 000 0067			
			45	18	8,25	.325	1,6	.063	3686 000 0074	3689 000 0074	3639 000 0074		
			32	13	9,32	3/8 P	1,3	.050					
			40	16	9,32	3/8 P	1,3	.050					
			45	18	9,32	3/8 P	1,3	.050					
			32	13	9,32	3/8	1,6	.063	3652 000 0050	3664 000 0050	3621 000 0050	3626 000 0050	
			37	15	9,32	3/8	1,6	.063	3652 000 0056	3664 000 0056	3621 000 0056	3626 000 0056	
			40	16	9,32	3/8	1,6	.063	3652 000 0060	3664 000 0060	3621 000 0060	3626 000 0060	
			45	18	9,32	3/8	1,6	.063	3652 000 0066	3664 000 0066	3621 000 0066	3626 000 0066	
	STIHL	MS 270, MS 280	32	13	8,25	.325	1,5	.058	3685 000 0056	3688 000 0056	3638 000 0056		
			37	15	8,25	.325	1,5	.058	3685 000 0062	3688 000 0062	3638 000 0062		
			32	13	8,25	.325	1,6	.063	3686 000 0056	3689 000 0056	3639 000 0056		
			37	15	8,25	.325	1,6	.063	3686 000 0062	3689 000 0062	3639 000 0062		
			40	16	8,25	.325	1,6	.063	3686 000 0067	3689 000 0067	3639 000 0067		
			45	18	8,25	.325	1,6	.063	3686 000 0074	3689 000 0074	3639 000 0074		
			32	13	9,32	3/8	1,6	.063	3652 000 0050	3664 000 0050	3621 000 0050	3626 000 0050	
			37	15	9,32	3/8	1,6	.063	3652 000 0056	3664 000 0056	3621 000 0056	3626 000 0056	
			40	16	9,32	3/8	1,6	.063	3652 000 0060	3664 000 0060	3621 000 0060	3626 000 0060	
			45	18	9,32	3/8	1,6	.063	3652 000 0066	3664 000 0066	3621 000 0066	3626 000 0066	
STIHL		MS 270, MS 280, MS 291	32	13	9,32	3/8	1,6	.063	3652 000 0050	3664 000 0050	3621 000 0050	3626 000 0050	
			37	15	9,32	3/8	1,6	.063	3652 000 0056	3664 000 0056	3621 000 0056	3626 000 0056	
			40	16	9,32	3/8	1,6	.063	3652 000 0060	3664 000 0060	3621 000 0060	3626 000 0060	
			45	18	9,32	3/8	1,6	.063	3652 000 0066	3664 000 0066	3621 000 0066	3626 000 0066	
					32	13	9,32	3/8	1,6	.063	3652 000 0072	3664 000 0072	3621 000 0072
	MS 270, MS 280, MS 291	32	13	9,32	3/8	1,6	.063	3652 000 0050	3664 000 0050	3621 000 0050	3626 000 0050		
		37	15	9,32	3/8	1,6	.063	3652 000 0056	3664 000 0056	3621 000 0056	3626 000 0056		
		40	16	9,32	3/8	1,6	.063	3652 000 0060	3664 000 0060	3621 000 0060	3626 000 0060		
		45	18	9,32	3/8	1,6	.063	3652 000 0066	3664 000 0066	3621 000 0066	3626 000 0066		
				32	13	9,32	3/8	1,6	.063	3652 000 0072	3664 000 0072	3621 000 0072	3626 000 0072
		STIHL	029, 039, MS 290, MS 310, MS 311, MS 390, MS 391	32	13	8,25	.325	1,5	.058	3685 000 0056	3688 000 0056	3638 000 0056	
				37	15	8,25	.325	1,5	.058	3685 000 0062	3688 000 0062	3638 000 0062	
				32	13	8,25	.325	1,6	.063	3686 000 0056	3689 000 0056	3639 000 0056	
				37	15	8,25	.325	1,6	.063	3686 000 0062	3689 000 0062	3639 000 0062	
				40	16	8,25	.325	1,6	.063	3686 000 0067	3689 000 0067	3639 000 0067	
		45	18	8,25	.325	1,6	.063	3686 000 0074	3689 000 0074	3639 000 0074			
		50	20	8,25	.325	1,6	.063	3686 000 0081	3689 000 0081	3639 000 0081			
		32	13	9,32	3/8	1,6	.063	3652 000 0050	3664 000 0050	3621 000 0050	3626 000 0050		
		37	15	9,32	3/8	1,6	.063	3652 000 0056	3664 000 0056	3621 000 0056	3626 000 0056		
		40	16	9,32	3/8	1,6	.063	3652 000 0060	3664 000 0060	3621 000 0060	3626 000 0060		
		45	18	9,32	3/8	1,6	.063	3652 000 0066	3664 000 0066	3621 000 0066	3626 000 0066		
		50	20	9,32	3/8	1,6	.063	3652 000 0072	3664 000 0072	3621 000 0072	3626 000 0072		
STIHL	08 S	43	17	9,32	3/8	1,6	.063	3652 000 0066	3664 000 0066	3621 000 0066	3626 000 0066		
		53	21	9,32	3/8	1,6	.063	3652 000 0075	3664 000 0075	3621 000 0075	3626 000 0075		
		43	17	10,26	.404	1,6	.063	3668 000 0060		3946 000 0060			
		53	21	10,26	.404	1,6	.063	3668 000 0068		3946 000 0068			
		63	25	10,26	.404	1,6	.063	3668 000 0080		3946 000 0080			
				43	17	10,26	.404	1,6	.063	3668 000 0060		3946 000 0060	

RSK
STIHL RAPID
Super K



RD3
STIHL RAPID
Duro 3

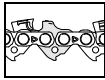

PS3
STIHL PICCO
Super 3

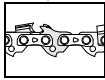

PM
STIHL PICCO
Micro



PM3
STIHL PICCO
Micro 3

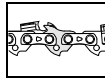

PD3
STIHL PICCO
Duro 3

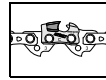

PMM3
STIHL PICCO
Micro Mini 3

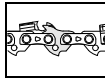

3666 000 0056
3666 000 0062

3667 000 0056
3667 000 0062
3667 000 0067
3667 000 0074

3613 000 0050 3636 000 0050 3612 000 0050
3613 000 0060 3636 000 0060 3612 000 0060
3613 000 0066 3636 000 0066 3612 000 0066

3898 000 0050 3683 000 0050
3898 000 0056 3683 000 0056
3898 000 0060 3683 000 0060
3898 000 0066 3683 000 0066

3666 000 0056
3666 000 0062

3667 000 0056
3667 000 0062
3667 000 0067
3667 000 0074

3898 000 0050 3683 000 0050
3898 000 0056 3683 000 0056
3898 000 0060 3683 000 0060
3898 000 0066 3683 000 0066

3666 000 0056
3666 000 0062

3667 000 0056
3667 000 0062
3667 000 0067
3667 000 0074
3667 000 0081

3898 000 0050 3683 000 0050
3898 000 0056 3683 000 0056
3898 000 0060 3683 000 0060
3898 000 0066 3683 000 0066
3898 000 0072 3683 000 0072

3898 000 0066 3683 000 0066
3898 000 0075 3683 000 0075

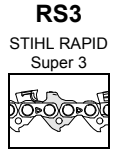
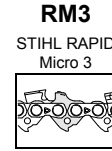
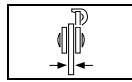
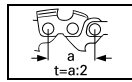
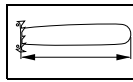

	cm	in.	mm	in.	mm	in.	RM STIHL RAPID Micro	RM3 STIHL RAPID Micro 3	RS STIHL RAPID Super	RS3 STIHL RAPID Super 3	
STIHL 034, 036, MS 340, MS 341, MS 360, MS 361, MS 362 MS 362 C	32	13	8,25	.325	1,5	.058	3685 000 0057	3688 000 0057	3638 000 0057		
	37	15	8,25	.325	1,5	.058	3685 000 0062	3688 000 0062	3638 000 0062		
	37	15	8,25	.325	1,5	.058	3685 000 0064	3688 000 0064	3638 000 0064		
	32	13	8,25	.325	1,6	.063	3686 000 0057	3689 000 0057	3639 000 0057		
	37	15	8,25	.325	1,6	.063	3686 000 0062	3689 000 0062	3639 000 0062		
	37	15	8,25	.325	1,6	.063	3686 000 0064	3689 000 0064	3639 000 0064		
	40	16	8,25	.325	1,6	.063	3686 000 0068	3689 000 0068	3639 000 0068		
	45	18	8,25	.325	1,6	.063	3686 000 0075	3689 000 0075	3639 000 0075		
	50	20	8,25	.325	1,6	.063	3686 000 0082	3689 000 0082	3639 000 0082		
		32	13	9,32	3/8	1,6	.063	3652 000 0050	3664 000 0050	3621 000 0050	3626 000 0050
	37	15	9,32	3/8	1,6	.063	3652 000 0056	3664 000 0056	3621 000 0056	3626 000 0056	
	40	16	9,32	3/8	1,6	.063	3652 000 0060	3664 000 0060	3621 000 0060	3626 000 0060	
	45	18	9,32	3/8	1,6	.063	3652 000 0066	3664 000 0066	3621 000 0066	3626 000 0066	
	50	20	9,32	3/8	1,6	.063	3652 000 0072	3664 000 0072	3621 000 0072	3626 000 0072	
STIHL 036 QS, MS 360 C-Q, MS 361 C-Q, MS 362 C-Q	32	13	8,25	.325	1,5	.058	3685 000 0057	3688 000 0057	3638 000 0057		
	37	15	8,25	.325	1,5	.058	3685 000 0064	3688 000 0064	3638 000 0064		
	32	13	8,25	.325	1,6	.063	3686 000 0057	3689 000 0057	3639 000 0057		
	37	15	8,25	.325	1,6	.063	3686 000 0064	3689 000 0064	3639 000 0064		
	40	16	8,25	.325	1,6	.063	3686 000 0068	3689 000 0068	3639 000 0068		
	45	18	8,25	.325	1,6	.063	3686 000 0075	3689 000 0075	3639 000 0075		
	50	20	8,25	.325	1,6	.063	3686 000 0082	3689 000 0082	3639 000 0082		
		32	13	9,32	3/8	1,6	.063	3652 000 0050	3664 000 0050	3621 000 0050	3626 000 0050
		37	15	9,32	3/8	1,6	.063	3652 000 0056	3664 000 0056	3621 000 0056	3626 000 0056
		40	16	9,32	3/8	1,6	.063	3652 000 0060	3664 000 0060	3621 000 0060	3626 000 0060
	45	18	9,32	3/8	1,6	.063	3652 000 0066	3664 000 0066	3621 000 0066	3626 000 0066	
	50	20	9,32	3/8	1,6	.063	3652 000 0072	3664 000 0072	3621 000 0072	3626 000 0072	
STIHL 038, MS 380, MS 381, MS 382	37	15	9,32	3/8	1,6	.063	3652 000 0056	3664 000 0056	3621 000 0056	3626 000 0056	
	40	16	9,32	3/8	1,6	.063	3652 000 0060	3664 000 0060	3621 000 0060	3626 000 0060	
	45	18	9,32	3/8	1,6	.063	3652 000 0066	3664 000 0066	3621 000 0066	3626 000 0066	
	50	20	9,32	3/8	1,6	.063	3652 000 0072	3664 000 0072	3621 000 0072	3626 000 0072	
	55	22	9,32	3/8	1,6	.063	3652 000 0076	3664 000 0076	3621 000 0076	3626 000 0076	
	63	25	9,32	3/8	1,6	.063	3652 000 0084	3664 000 0084	3621 000 0084	3626 000 0084	
	71	28	9,32	3/8	1,6	.063	3652 000 0091		3621 000 0091	3626 000 0091	
STIHL 044, 046, MS 440, MS 441, MS 441 C, MS 460, MS 461	37	15	8,25	.325	1,6	.063	3686 000 0064	3689 000 0064	3639 000 0064		
	40	16	8,25	.325	1,6	.063	3686 000 0068	3689 000 0068	3639 000 0068		
	45	18	8,25	.325	1,6	.063	3686 000 0075	3689 000 0075	3639 000 0075		
	50	20	8,25	.325	1,6	.063	3686 000 0082	3689 000 0082	3639 000 0082		
	37	15	9,32	3/8	1,6	.063	3652 000 0056	3664 000 0056	3621 000 0056	3626 000 0056	
	40	16	9,32	3/8	1,6	.063	3652 000 0060	3664 000 0060	3621 000 0060	3626 000 0060	
	45	18	9,32	3/8	1,6	.063	3652 000 0066	3664 000 0066	3621 000 0066	3626 000 0066	
	50	20	9,32	3/8	1,6	.063	3652 000 0072	3664 000 0072	3621 000 0072	3626 000 0072	
	55	22	9,32	3/8	1,6	.063	3652 000 0076	3664 000 0076	3621 000 0076	3626 000 0076	
	63	25	9,32	3/8	1,6	.063	3652 000 0084	3664 000 0084	3621 000 0084	3626 000 0084	
	75	30	9,32	3/8	1,6	.063	3652 000 0098	3664 000 0098	3621 000 0098	3626 000 0098	
	80	32	9,32	3/8	1,6	.063	3652 000 0105	3664 000 0105	3621 000 0105	3626 000 0105	
	90	36	9,32	3/8	1,6	.063	3652 000 0114	3664 000 0114	3621 000 0114	3626 000 0114	
MS 462	40	16	9,32	3/8	1,6	.063	3652 000 0060	3664 000 0060	3621 000 0060	3626 000 0060	
	45	18	9,32	3/8	1,6	.063	3652 000 0066	3664 000 0066	3621 000 0066	3626 000 0066	
	50	20	9,32	3/8	1,6	.063	3652 000 0072	3664 000 0072	3621 000 0072	3626 000 0072	
	55	22	9,32	3/8	1,6	.063	3652 000 0076	3664 000 0076	3621 000 0076	3626 000 0076	
	63	25	9,32	3/8	1,6	.063	3652 000 0084	3664 000 0084	3621 000 0084	3626 000 0084	
	71	28	9,32	3/8	1,6	.063	3652 000 0091	3664 000 0092	3621 000 0098	3626 000 0091	
	75	30	9,32	3/8	1,6	.063	3652 000 0098	3664 000 0098	3621 000 0098	3626 000 0098	
		90	36	9,32	3/8	1,6	.063				
MS 460 R, MS 461 R, MS 462 R	50	20	9,32	3/8	1,6	.063					

RSK
STIHL RAPID
Super K



RD3
STIHL RAPID
Duro 3

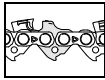

PS3
STIHL PICCO
Super 3

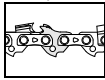

PM
STIHL PICCO
Micro



PM3
STIHL PICCO
Micro 3

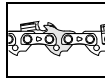

PD3
STIHL PICCO
Duro 3

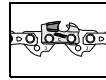

PMM3
STIHL PICCO
Micro Mini 3

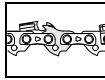

3666 000 0057
3666 000 0062
3666 000 0064

3667 000 0057
3667 000 0062
3667 000 0064
3667 000 0068
3667 000 0075
3667 000 0082

3869 000 0050 3683 000 0050
3898 000 0056 3683 000 0056
3898 000 0060 3683 000 0060
3898 000 0066 3683 000 0066
3898 000 0072 3683 000 0072

3666 000 0057
3666 000 0064

3667 000 0057
3667 000 0064
3667 000 0068
3667 000 0075
3667 000 0082

3898 000 0050 3683 000 0050
3898 000 0056 3683 000 0056
3898 000 0060 3683 000 0060
3898 000 0066 3683 000 0066
3898 000 0072 3683 000 0072

3898 000 0056 3683 000 0056
3898 000 0060 3683 000 0060
3898 000 0066 3683 000 0066
3898 000 0072 3683 000 0072
3898 000 0076 3683 000 0076
3898 000 0084 3683 000 0084
3898 000 0088 3683 000 0091

3667 000 0064
3667 000 0068
3667 000 0075
3667 000 0082

3898 000 0056 3683 000 0056
3898 000 0060 3683 000 0060
3898 000 0066 3683 000 0066
3898 000 0072 3683 000 0072
3898 000 0076 3683 000 0076
3898 000 0084 3683 000 0084
3898 000 0098 3683 000 0098
3898 000 0105 3683 000 0105
3898 000 0114 3683 000 0114

3683 000 0060
3683 000 0066
3683 000 0072
3683 000 0076
3683 000 0084
3683 000 0091
3683 000 0098

3944 000 0072¹

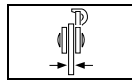
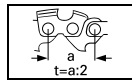
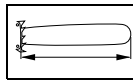

cm in. mm in. mm in.

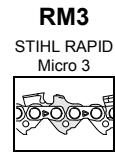

STIHL 064, 066, MS 640, MS 650, MS 651, MS 660, MS 661, MS 661 C	40	16	9,32	3/8	1,6	.063		3652 000 0060	3664 000 0060		
	45	18	9,32	3/8	1,6	.063		3652 000 0066	3664 000 0066		
	50	20	9,32	3/8	1,6	.063		3652 000 0072	3664 000 0072		
	55	22	9,32	3/8	1,6	.063		3652 000 0076	3664 000 0076		
	63	25	9,32	3/8	1,6	.063		3652 000 0084	3664 000 0084		
	71	28	9,32	3/8	1,6	.063		3652 000 0091	3664 000 0091	3621 000 0091	
	75	30	9,32	3/8	1,6	.063		3652 000 0098	3664 000 0098		
	80	32	9,32	3/8	1,6	.063		3652 000 0105	3664 000 0105		
	90	36	9,32	3/8	1,6	.063		3652 000 0114	3664 000 0114		
		40	16	10,26	.404	1,6	.063		3668 000 0055		
	45	18	10,26	.404	1,6	.063		3668 000 0060			
	50	20	10,26	.404	1,6	.063		3668 000 0066			
	63	25	10,26	.404	1,6	.063		3668 000 0077			
	75	30	10,26	.404	1,6	.063		3668 000 0088			
	80	32	10,26	.404	1,6	.063		3668 000 0095			
	90	36	10,26	.404	1,6	.063		3668 000 0104			
064, 066, MS 640, MS 660, MS 661, LOGOSOL	45	18	9,32	3/8 P	1,3	.050					
	50	20	9,32	3/8 P	1,3	.050					
	63	25	9,32	3/8 P	1,3	.050					
	45	18	9,32	3/8	1,6	.063		3653 000 0066			
	50	20	9,32	3/8	1,6	.063		3653 000 0072			
	63	25	9,32	3/8	1,6	.063		3653 000 0084			
	50	20	10,26	.404	1,6	.063		3838 000 0066			
	63	25	10,26	.404	1,6	.063		3838 000 0077			
STIHL 051, 075, 076	53	21	9,32	3/8	1,6	.063		3652 000 0075	3664 000 0075		
	63	25	9,32	3/8	1,6	.063		3652 000 0088	3664 000 0088		
	75	30	9,32	3/8	1,6	.063		3652 000 0100	3664 000 0100		
	(076)	90	36	9,32	3/8	1,6	.063	3652 000 0114	3664 000 0114		
	(076)	105	41	9,32	3/8	1,6	.063	3652 000 0135	3664 000 0135		
	(076)	120	47	9,32	3/8	1,6	.063	3652 000 0152	3664 000 0152		
	(076)	150	59	9,32	3/8	1,6	.063	3652 000 0189	3664 000 0189		
		43	17	10,26	.404	1,6	.063		3668 000 0060		
		53	21	10,26	.404	1,6	.063		3668 000 0068		
		63	25	10,26	.404	1,6	.063		3668 000 0080		
	75	30	10,26	.404	1,6	.063		3668 000 0091			
(076)	90	36	10,26	.404	1,6	.063		3668 000 0108 ²			
(076)	90	36	10,26	.404	1,6	.063		3668 000 0104 ³			
(076)	105	41	10,26	.404	1,6	.063		3668 000 0123			
(076)	120	47	10,26	.404	1,6	.063		3668 000 0138			
(076)	150	59	10,26	.404	1,6	.063		3668 000 0173			

1 =  7, 2 = Rollomatic, 3 = Duromatic, 4 = PMX

RS3

STIHL RAPID
Super 3

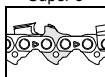

RSK

STIHL RAPID
Super K



RD3

STIHL RAPID
Duro 3

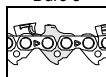

PM

STIHL PICCO
Micro



PM3

STIHL PICCO
Micro 3

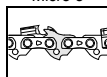

PD3

STIHL PICCO
Duro 3

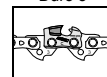

PMM3

STIHL PICCO
Micro Mini 3

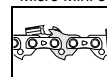

3626 000 0060	3898 000 0060	3683 000 0060
3626 000 0066	3898 000 0066	3683 000 0066
3626 000 0072	3898 000 0072	3683 000 0072
3626 000 0076	3898 000 0076	3683 000 0076
3626 000 0084	3898 000 0084	3683 000 0084
3626 000 0091		3683 000 0091
3626 000 0098	3898 000 0098	3683 000 0098
3626 000 0105	3898 000 0105	3683 000 0105
3626 000 0114	3898 000 0114	3683 000 0114

3846 000 0055
3846 000 0060
3846 000 0066
3846 000 0077
3846 000 0088
3846 000 0095
3846 000 0104

3614 000 0066⁴
3614 000 0072⁴
3614 000 0084⁴

3626 000 0075	3898 000 0075	3683 000 0075
3626 000 0088	3898 000 0088	3683 000 0088
3626 000 0100	3898 000 0100	3683 000 0100
3626 000 0114	3898 000 0114	3683 000 0114
3626 000 0135	3898 000 0135	3683 000 0135
3626 000 0152	3898 000 0152	3683 000 0152
3626 000 0189	3898 000 0189	3683 000 0189

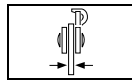
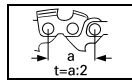
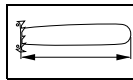

3846 000 0060
3846 000 0068
3846 000 0080
3846 000 0091
3846 000 0108²
3846 000 0104³
3846 000 0123
3846 000 0138
3846 000 0173

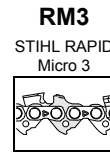

cm in. mm in. mm in.



STIHL 084, 088, MS 780, MS 880	53	21	9,32	3/8	1,6	.063		3652 000 0075	3664 000 0075	3621 000 0075
	63	25	9,32	3/8	1,6	.063		3652 000 0088	3664 000 0088	3621 000 0088
	75	30	9,32	3/8	1,6	.063		3652 000 0100	3664 000 0100	3621 000 0100
	90	36	9,32	3/8	1,6	.063		3652 000 0114	3664 000 0114	3621 000 0114
	105	41	9,32	3/8	1,6	.063		3652 000 0135	3664 000 0135	3621 000 0135
	120	47	9,32	3/8	1,6	.063		3652 000 0152	3664 000 0152	3621 000 0152
	150	59	9,32	3/8	1,6	.063		3652 000 0189	3664 000 0189	3621 000 0189
	43	17	10,26	.404	1,6	.063		3668 000 0060 ¹		3946 000 0060 ¹
	53	21	10,26	.404	1,6	.063		3668 000 0068 ¹		3946 000 0068 ¹
	63	25	10,26	.404	1,6	.063		3668 000 0080 ¹		3946 000 0080 ¹
75	30	10,26	.404	1,6	.063		3668 000 0091 ¹		3946 000 0091 ¹	
90	36	10,26	.404	1,6	.063		3668 000 0108 ^{1,2}		3946 000 0108 ^{1,2}	
90	36	10,26	.404	1,6	.063		3668 000 0104 ^{1,3}		3946 000 0104 ^{1,3}	
105	41	10,26	.404	1,6	.063		3668 000 0123 ¹		3946 000 0123 ¹	
120	47	10,26	.404	1,6	.063		3668 000 0138 ¹		3946 000 0138 ¹	
150	59	10,26	.404	1,6	.063		3668 000 0173 ¹		3946 000 0173 ¹	
STIHL 070, 090, MS 720	53	21	10,26	.404	1,6	.063		3668 000 0072		3946 000 0072
	63	25	10,26	.404	1,6	.063		3668 000 0084		3946 000 0084
	75	30	10,26	.404	1,6	.063		3668 000 0092		3946 000 0092
	80	32	10,26	.404	1,6	.063		3668 000 0100		3946 000 0100
	90	36	10,26	.404	1,6	.063		3668 000 0104		3946 000 0104
	105	41	10,26	.404	1,6	.063		3668 000 0123		3946 000 0123
	120	47	10,26	.404	1,6	.063		3668 000 0139		3946 000 0139
	150	59	10,26	.404	1,6	.063		3668 000 0173		3946 000 0173
STIHL 090 G	63	25	10,26	.404	1,6	.063		3668 000 0080		3946 000 0080
	75	30	10,26	.404	1,6	.063		3668 000 0092		3946 000 0092
	90	36	10,26	.404	1,6	.063		3668 000 0104		3946 000 0104
	105	41	10,26	.404	1,6	.063		3668 000 0123		3946 000 0123
	120	47	10,26	.404	1,6	.063		3668 000 0139		3946 000 0139
	150	59	10,26	.404	1,6	.063		3668 000 0173		3946 000 0173
STIHL MC 200	30	12	9,32	3/8 P	1,1	.043				
STIHL E 140, E 160, E 180, MSE 140,140 C, MSE 160,160 C, MSE 170 C, MSE 180,180 C, MSE 190 C, MSE 200,200 C, MSE 210 C, MSE 230 C	30	12	9,32	3/8 P	1,3	.050				
	35	14	9,32	3/8 P	1,3	.050				
	40	16	9,32	3/8 P	1,3	.050				
	45	18	9,32	3/8 P	1,3	.050				
	35	14	9,32	3/8 P	1,3	.050				
	40	16	9,32	3/8 P	1,3	.050				
	45	18	9,32	3/8 P	1,3	.050				
	25	10	6,35	1/4	1,3	.050	3661 000 0056	3660 000 0056		
	30	12	6,35	1/4	1,3	.050	3661 000 0064	3660 000 0064		
	(E 140), (MSE 140)	30	12	9,32	3/8 P	1,1	.043			
	35	14	9,32	3/8 P	1,1	.043				
	40	16	9,32	3/8 P	1,1	.043				
MSE 141 C	25	10	9,32	3/8 P	1,1	.043				
	30	12	9,32	3/8 P	1,1	.043				
	35	14	9,32	3/8 P	1,1	.043				
	40	16	9,32	3/8 P	1,1	.043				
	30	12	9,32	3/8 P	1,3	.050				
	35	14	9,32	3/8 P	1,3	.050				
	40	16	9,32	3/8 P	1,3	.050				
	45	18	9,32	3/8 P	1,3	.050				

1 =  7, 2 = Rollomatic, 3 = Duromatic, 4 = PMX, 5 =  7 Z

RS3

STIHL RAPID
Super 3

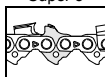

RSK

STIHL RAPID
Super K



RD3

STIHL RAPID
Duro 3

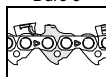

PM

STIHL PICCO
Micro



PM3

STIHL PICCO
Micro 3

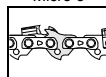

PD3

STIHL PICCO
Duro 3

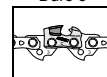

PMM3

STIHL PICCO
Micro Mini 3



3626 000 0075	3898 000 0075	3683 000 0075
3626 000 0088	3898 000 0088	3683 000 0088
3626 000 0100	3898 000 0100	3683 000 0100
3626 000 0114	3898 000 0114	3683 000 0114
3626 000 0135	3898 000 0135	3683 000 0135
3626 000 0152	3898 000 0152	3683 000 0152
3626 000 0189	3898 000 0189	3683 000 0189

3846 000 0060¹
3846 000 0068¹
3846 000 0080¹
3846 000 0091¹
3846 000 0108^{1,2}
3846 000 0104^{1,3}
3846 000 0123¹
3846 000 0138¹
3846 000 0173¹

3846 000 0072
3846 000 0084
3846 000 0092
3846 000 0100
3846 000 0104
3846 000 0123
3846 000 0139
3846 000 0173

3846 000 0080
3846 000 0092
3846 000 0104
3846 000 0123
3846 000 0139
3846 000 0173

3610 000 0044

3613 000 0044	3636 000 0044	3612 000 0044
3613 000 0050	3636 000 0050	3612 000 0050
3613 000 0055	3636 000 0055	3612 000 0055
3613 000 0061	3636 000 0061	3612 000 0061

3613 000 0051 ⁵	3636 000 0051 ⁵	3612 000 0051 ⁵
3613 000 0056 ⁵	3636 000 0056 ⁵	3612 000 0056 ⁵
3613 000 0062 ⁵	3636 000 0062 ⁵	3612 000 0062 ⁵

3610 000 0045
3610 000 0051
3610 000 0056

3610 000 0039
3610 000 0045
3610 000 0050
3610 000 0056

3613 000 0044	3636 000 0044	3612 000 0044
3613 000 0050	3636 000 0050	3612 000 0050
3613 000 0055	3636 000 0055	3612 000 0055
3613 000 0061	3636 000 0061	3612 000 0061

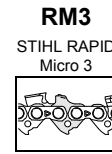
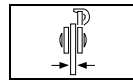
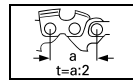
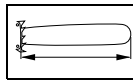

STIHL E 20, E 220, MSE 220	cm		in.		mm		in.		RMS STIHL RAPID Micro Spezial	RM STIHL RAPID Micro	RM3 STIHL RAPID Micro 3	RS STIHL RAPID Super
	cm	in.	mm	in.	mm	in.						
	37	15	8,25	.325	1,6	.063						
	40	16	8,25	.325	1,6	.063			3686 000 0063	3689 000 0056	3639 000 0063	
	45	18	8,25	.325	1,6	.063			3686 000 0067	3689 000 0067	3639 000 0067	
	50	20	8,25	.325	1,6	.063			3686 000 0074	3689 000 0074	3639 000 0074	
									3686 000 0081	3689 000 0081	3639 000 0081	

	37	15	9,32	3/8	1,6	.063			3652 000 0057	3664 000 0057	3621 000 0057	
	40	16	9,32	3/8	1,6	.063			3652 000 0060	3664 000 0060	3621 000 0060	
	45	18	9,32	3/8	1,6	.063			3652 000 0066	3664 000 0066	3621 000 0066	
	50	20	9,32	3/8	1,6	.063			3652 000 0072	3664 000 0072	3621 000 0072	

STIHL MSE 250	37	15	9,32	3/8	1,6	.063			3652 000 0057	3664 000 0057	3621 000 0057	
	40	16	9,32	3/8	1,6	.063			3652 000 0060	3664 000 0060	3621 000 0060	
	45	18	9,32	3/8	1,6	.063			3652 000 0066	3664 000 0066	3621 000 0066	
	50	20	9,32	3/8	1,6	.063			3652 000 0072	3664 000 0072	3621 000 0072	

STIHL MSA 120 C, MSA 140 C	25	10	6,35	1/4 P	1,1	.043						
MSA 160 C MSA 200 C	30	12	6,35	1/4 P	1,1	.043						
(MSA 160 C, MSA 200 C)	35	14	6,35	1/4 P	1,1	.043						
	30	12	9,32	3/8 P	1,1	.043						

STIHL MSA 160 T,	25	10	6,35	1/4 P	1,1	.043						
	30	12	6,35	1/4 P	1,1	.043						

STIHL MSA 161 T	25	10	6,35	1/4 P	1,1	.043						
	30	12	6,35	1/4 P	1,1	.043						

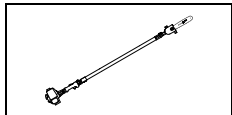

STIHL HTE 60, HT 56, 70, 75, HT 100, 101, HT 130, 131, HT, HT-KM	25	10	6,35	1/4 P	1,1	.043						
	30	12	6,35	1/4 P	1,1	.043						
	35	14	6,35	1/4 P	1,1	.043						
	30	12	9,32	3/8 P	1,1	.043						

HT 70K	30	12	9,32	3/8 P	1,3	.050						
--------	----	----	------	-------	-----	------	--	--	--	--	--	--

HT 121	30	12	6,35	1/4 P	1,1	.043						
--------	----	----	------	-------	-----	------	--	--	--	--	--	--

HT 102,	25	10	6,35	1/4 P	1,1	.043						
HT 103	30	12	6,35	1/4 P	1,1	.043						
HT 132	35	14	6,35	1/4 P	1,1	.043						
HT 133												

STIHL HTA 65, HTA 85	25	10	6,35	1/4 P	1,1	.043						
	30	12	6,35	1/4 P	1,1	.043						
	35	14	6,35	1/4 P	1,1	.043						

RS3
STIHL RAPID
Super 3

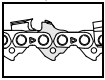

RSK
STIHL RAPID
Super K



RD3
STIHL RAPID
Duro 3

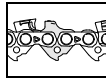

PM
STIHL PICCO
Micro



PM3
STIHL PICCO
Micro 3

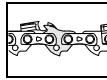

PD3
STIHL PICCO
Duro 3

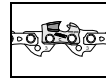

PMM3
STIHL PICCO
Micro Mini 3

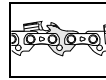

3626 000 0057	3898 000 0057	3683 000 0057
3626 000 0060	3898 000 0060	3683 000 0060
3626 000 0066	3898 000 0066	3683 000 0066
3626 000 0072	3898 000 0072	3683 000 0072

3626 000 0057	3898 000 0057	3683 000 0057
3626 000 0060	3898 000 0060	3683 000 0060
3626 000 0066	3898 000 0066	3683 000 0066
3626 000 0072	3898 000 0072	3683 000 0072

3670 000 0056
3670 000 0064
3670 000 0072

3610 000 0044

3670 000 0056
3670 000 0064

3670 000 0057
3670 000 0065

3670 000 0056
3670 000 0064
3670 000 0072

3610 000 0044

3636 000 0044

3670 000 0064

3670 000 0056
3670 000 0064
3670 000 0072

3670 000 0056
3670 000 0064
3670 000 0072

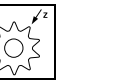
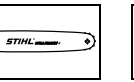
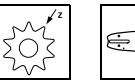
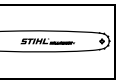
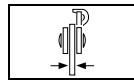
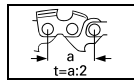
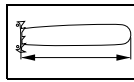

		cm	in.	mm	in.	mm	in.	STIHL Rollomatic E		STIHL Rollomatic E	
STIHL 009, 010, 011, 012 (011, 012) (009) (009) (009)		30	12	9,32	3/8 P	1,3	.050	44	3005 000 4805	9	
		35	14	9,32	3/8 P	1,3	.050	50	3005 000 4809	9	
		40	16	9,32	3/8 P	1,3	.050	55	3005 008 4813	9	
		45	18	9,32	3/8 P	1,3	.050	61	3005 000 4817	9	
		30	12	9,32	3/8 P	1,1	.043	44	3005 000 3905 ¹	7	
		35	14	9,32	3/8 P	1,1	.043	50	3005 008 3909 ¹	7	
		40	16	9,32	3/8 P	1,1	.043	55	3005 008 3913 ¹	7	
		30	12	6,35	1/4	1,3	.050	64			
		35	14	8,25	.325	1,5	.058	56	3005 000 5009	11	
		35	14	8,25	.325	1,6	.063	56	3005 000 4709	11	
	40	16	8,25	.325	1,6	.063	62	3005 008 4713	11		
	45	18	8,25	.325	1,6	.063	68	3005 008 4717	11		
STIHL MS 150, MS 150 T		25	10	6,35	1/4 P	1,1	.043	56	3005 008 3403 ¹	8	
		30	12	6,35	1/4 P	1,1	.043	64	3005 008 3405 ¹	8	
		30	12	9,32	3/8 P	1,1	.043	44	3005 000 3905 ¹	7	
		35	14	9,32	3/8 P	1,1	.043	50	3005 008 3909 ¹	7	
STIHL 017, 018, MS 170, MS 180, MS 171, MS 181		30	12	9,32	3/8 P	1,1	.043	44	3005 000 3905 ¹	7	
		35	14	9,32	3/8 P	1,1	.043	50	3005 008 3909 ¹	7	
		40	16	9,32	3/8 P	1,1	.043	55	3005 008 3913 ¹	7	
		30	12	9,32	3/8 P	1,3	.050	44			
		30	12	9,32	3/8 P	1,3	.050	44	3005 000 4805	9	
		35	14	9,32	3/8 P	1,3	.050	50	3005 000 4809	9	
		40	16	9,32	3/8 P	1,3	.050	55			
		30	12	6,35	1/4	1,3	.050	64			
STIHL 019 T, MS 190 T		30	12	9,32	3/8 P	1,1	.043	44	3005 000 3905 ¹	7	
		35	14	9,32	3/8 P	1,1	.043	50	3005 008 3909 ¹	7	
		40	16	9,32	3/8 P	1,1	.043	55	3005 008 3913 ¹	7	
		30	12	9,32	3/8 P	1,3	.050	44			
		30	12	9,32	3/8 P	1,3	.050	44	3005 000 4805	9	
		35	14	9,32	3/8 P	1,3	.050	50	3005 000 4809	9	
		40	16	9,32	3/8 P	1,3	.050	55			
		40	16	9,32	3/8 P	1,3	.050	55	3005 008 4813	9	
		30	12	6,35	1/4	1,3	.050	64			
	STIHL MS 192 C, MS 192 T, MS 193 C, MS 193 T		30	12	9,32	3/8 P	1,1	.043	44	3005 000 3905 ¹	7
		35	14	9,32	3/8 P	1,1	.043	50	3005 008 3909 ¹	7	
		30	12	9,32	3/8 P	1,3	.050	43	3005 000 4805	9	
		30	12	9,32	3/8 P	1,3	.050	44			
		35	14	9,32	3/8 P	1,3	.050	50	3005 000 4809	9	
		40	16	9,32	3/8 P	1,3	.050	55			
		40	16	9,32	3/8 P	1,3	.050	55	3005 008 4813	9	
		45	18	9,32	3/8 P	1,3	.050	61	3005 000 4817	9	
		30	12	6,35	1/4	1,3	.050	64			
		MS 192 T, MS 193 T	25	10	6,35	1/4 P	1,1	.043	56		
		30	12	6,35	1/4 P	1,1	.043	64			
		35	14	6,35	1/4 P	1,1	.043	72			

1 = Rollomatic E Mini



STIHL
Rollomatic E Super



STIHL
Rollomatic E Light

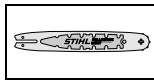

STIHL
Rollomatic E Mini Light

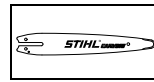

STIHL
Carving E

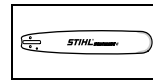

STIHL
Duromatic E

3005 000 7405 9
3005 000 7409 9
3005 000 7413 9

3005 000 3205

3005 000 3105

3005 000 7605 7
3005 000 7609 7

3005 000 7605 7
3005 000 7609 7

3005 000 7405 9
3005 000 7409 9
3005 000 7413 9

3005 000 3205

3005 000 7405 9
3005 000 7409 9
3005 000 7413 9

3005 000 3205

3005 000 7605 7
3005 000 7609 7

3005 000 7405 9
3005 000 7409 9
3005 000 7413 9

3005 000 3205

3005 008 3403
3005 008 3405
3005 008 3409

3005 000 3105

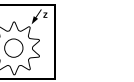
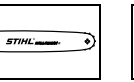
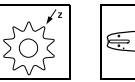
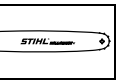
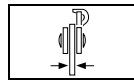
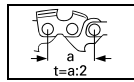
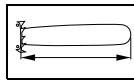

	cm	in.	mm	in.	mm	in.		STIHL Rollomatic E	STIHL Rollomatic E
STIHL 020,020 T	30	12	9,32	3/8 P	1,3	.050	44		
STIHL MS 200	30	12	9,32	3/8 P	1,3	.050	44	3005 000 4805	9
MS 200 T,	35	14	9,32	3/8 P	1,3	.050	50	3005 000 4809	9
MS 201,	40	16	9,32	3/8 P	1,3	.050	55		
MS 201 C,	40	16	9,32	3/8 P	1,3	.050	55	3005 008 4813	9
MS 201 T,	45	18	9,32	3/8 P	1,3	.050	61	3005 000 4817	9
MS 201 TC									
(020, MS 200)	30	12	6,35	1/4	1,3	.050	64		
(020, MS 200)	35	14	8,25	.325	1,6	.063	56	3005 000 4709	11
	40	16	8,25	.325	1,6	.063	62	3005 008 4713	11
	45	18	8,25	.325	1,6	.063	68	3005 008 4717	11
STIHL 021, 023, 025,	30	12	9,32	3/8 P	1,3	.050	44		
MS 210,	30	12	9,32	3/8 P	1,3	.050	44	3005 000 4805	9
MS 230, 231,	35	14	9,32	3/8 P	1,3	.050	50	3005 000 4809	9
MS 241 C,	40	16	9,32	3/8 P	1,3	.050	55		
MS 250, 251,	40	16	9,32	3/8 P	1,3	.050	55	3005 008 4813	9
MS 211	45	18	9,32	3/8 P	1,3	.050	61	3005 000 4817	9
(025, MS 250)	35	14	9,32	3/8 P	1,3	.050	51 ²	3005 000 4809	9
	40	16	9,32	3/8 P	1,3	.050	56 ²		
	40	16	9,32	3/8 P	1,3	.050	56 ²	3005 008 4813	9
	45	18	9,32	3/8 P	1,3	.050	62 ²	3005 000 4817	9
(023 L),	30	12	9,32	3/8 P	1,1	.043	44	3005 000 3905 ¹	7
(MS 230)									
(023 L)	35	14	9,32	3/8 P	1,1	.043	50	3005 008 3909 ¹	7
(023 L)	40	16	9,32	3/8 P	1,1	.043	55	3005 008 3913 ¹	7
021, 023, 025,	30	12	6,35	1/4	1,3	.050	64		
MS 210,	35	14	8,25	.325	1,5	.058	56	3005 000 5009	11
MS 230, 231,	35	14	8,25	.325	1,5	.058	56	3005 000 5009	11
MS 241,	35	14	8,25	.325	1,6	.063	56	3005 000 4709	11
MS 250, 251	40	16	8,25	.325	1,6	.063	62	3005 008 4713	11
(025, MS 250)	45	18	8,25	.325	1,6	.063	68	3005 008 4717	11
	50	20	8,25	.325	1,6	.063	76	3005 000 4721	11
STIHL 024, MS 240,	32	13	8,25	.325	1,5	.058	56	3003 000 5006	11
026, MS 260,	37	15	8,25	.325	1,5	.058	62	3003 000 5011	11
MS 261,	32	13	8,25	.325	1,6	.063	56	3003 000 5306	11
MS 261 C,	37	15	8,25	.325	1,6	.063	62	3003 000 6811	11
MS 261 C-Q	40	16	8,25	.325	1,6	.063	67	3003 000 6813	11
	45	18	8,25	.325	1,6	.063	74	3003 008 6817	11
	32	13	9,32	3/8 P	1,3	.050	50	3003 000 6306	9
	40	16	9,32	3/8 P	1,3	.050	60	3003 000 6313	9
	45	18	9,32	3/8 P	1,3	.050	66	3003 000 6317	9

1 = Rollomatic E Mini, 2 =  7 Z

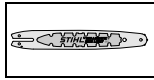
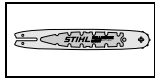

STIHL
Rollomatic E Super

STIHL
Rollomatic E Light

STIHL
Rollomatic E Mini Light

STIHL
Carving E

STIHL
Duromatic E

3005 000 7405 9
3005 000 7409 9
3005 000 7413 9

3005 000 3205

3005 000 7405 9
3005 000 7409 9
3005 000 7413 9

3005 000 7409 9
3005 000 7413 9

3005 000 3205

3003 000 9211
3003 000 9213
3003 000 9217

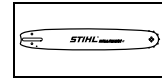
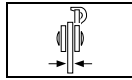
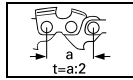
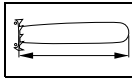

		cm	in.	mm	in.	mm	in.	STIHL Rollomatic E		STIHL Rollomatic E	
=> 026, MS 260		32	13	9,32	3/8	1,6	.063	50	3003 000 6106	10	
		37	15	9,32	3/8	1,6	.063	56	3003 000 6111	10	3003 000 5211 11
		40	16	9,32	3/8	1,6	.063	60	3003 000 6113	10	3003 000 5213 11
		45	18	9,32	3/8	1,6	.063	66	3003 008 6117	10	3003 000 5217 11
STIHL MS 270, MS 270 C, MS 280, MS 280 C		32	13	8,25	.325	1,5	.058	56	3003 000 5006	11	
		37	15	8,25	.325	1,5	.058	62	3003 000 5011	11	
		32	13	8,25	.325	1,6	.063	56	3003 000 5306	11	
		37	15	8,25	.325	1,6	.063	62	3003 000 6811	11	
	40	16	8,25	.325	1,6	.063	67	3003 000 6813	11		
	45	18	8,25	.325	1,6	.063	74	3003 008 6817	11		
	32	13	9,32	3/8	1,6	.063	50	3003 000 6106	10		
	37	15	9,32	3/8	1,6	.063	56	3003 000 6111	10	3003 000 5211 11	
	40	16	9,32	3/8	1,6	.063	60	3003 000 6113	10	3003 000 5213 11	
	45	18	9,32	3/8	1,6	.063	66	3003 008 6117	10	3003 000 5217 11	
STIHL MS 270 C-Q, MS 280 C-Q		32	13	8,25	.325	1,5	.058	56	3003 000 5006	11	
		37	15	8,25	.325	1,5	.058	62	3003 000 5011	11	
		32	13	8,25	.325	1,6	.063	56	3003 000 5306	11	
		37	15	8,25	.325	1,6	.063	62	3003 000 6811	11	
	40	16	8,25	.325	1,6	.063	67	3003 000 6813	11		
	45	18	8,25	.325	1,6	.063	74	3003 008 6817	11		
STIHL MS 271, MS 291, MS 291 C-Q		32	13	8,25	.325	1,5	.058	56	3003 000 5006	11	
		37	15	8,25	.325	1,5	.058	62	3003 000 5011	11	
		32	13	8,25	.325	1,6	.063	56	3003 000 5306	11	
		37	15	8,25	.325	1,6	.063	62	3003 000 6811	11	
	40	16	8,25	.325	1,6	.063	67	3003 000 6813	11		
	45	18	8,25	.325	1,6	.063	74	3003 008 6817	11		
MS 291		32	13	9,32	3/8	1,6	.063	50	3003 000 6106	10	
		37	15	9,32	3/8	1,6	.063	56	3003 000 6111	10	3003 000 5211 11
		40	16	9,32	3/8	1,6	.063	60	3003 000 6113	10	3003 000 5213 11
		45	18	9,32	3/8	1,6	.063	66	3003 008 6117	10	3003 000 5217 11
STIHL 029, 039, MS 290, MS 310, MS 311, MS 390, MS 391		32	13	8,25	.325	1,5	.058	56	3003 000 5006	11	
		37	15	8,25	.325	1,5	.058	62	3003 000 5011	11	
		32	13	8,25	.325	1,6	.063	56	3003 000 5306	11	
		37	15	8,25	.325	1,6	.063	62	3003 000 6811	11	
		40	16	8,25	.325	1,6	.063	67	3003 000 6813	11	
		45	18	8,25	.325	1,6	.063	74	3003 008 6817	11	
		50	20	8,25	.325	1,6	.063	81	3003 008 6821	11	
		32	13	9,32	3/8	1,6	.063	50	3003 000 6106	10	
		37	15	9,32	3/8	1,6	.063	56	3003 000 6111	10	3003 000 5211 11
		40	16	9,32	3/8	1,6	.063	60	3003 000 6113	10	3003 000 5213 11
	45	18	9,32	3/8	1,6	.063	66	3003 008 6117	10	3003 000 5217 11	
	50	20	9,32	3/8	1,6	.063	72	3003 008 6121	10	3003 000 5221 11	



STIHL

Rollomatic E Super



STIHL

Rollomatic E Super Light



STIHL

Rollomatic E Mini Light



STIHL

Carving E

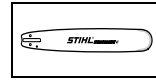

STIHL

Duromatic E

3003 000 9413	11				3003 000 9211
3003 000 9417	11				3003 000 9213
					3003 000 9217



					3003 000 9211
					3003 000 9213
					3003 000 9217

3003 000 9413	11				3003 000 9211
3003 000 9417	11				3003 000 9213
					3003 000 9217

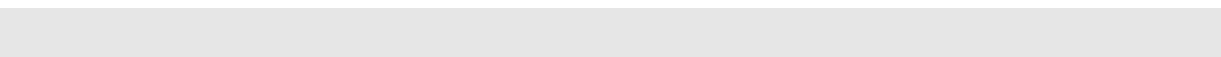

					3003 000 9211
					3003 000 9213
					3003 000 9217

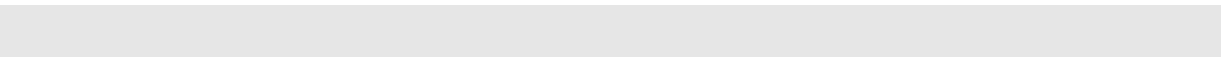

					3003 000 9211
					3003 000 9213
					3003 000 9217

3003 000 9413	11				3003 000 9211
3003 000 9417	11				3003 000 9213
					3003 000 9217

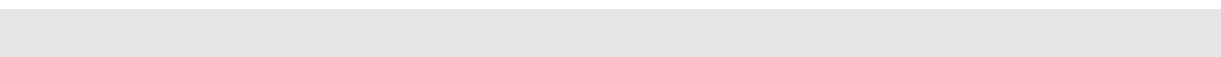

					3003 000 9211
					3003 000 9213
					3003 000 9217
					3003 000 9221

3003 000 9413	11				3003 000 9211
3003 000 9417	11				3003 000 9213
3003 000 9421	11	3003 000 2021	11		3003 000 9217
					3003 000 9221

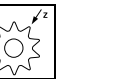
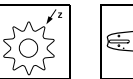
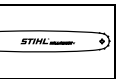
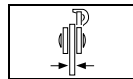
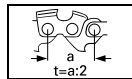
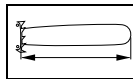

cm

in.

mm

in.

mm

in.

STIHL
Rollomatic ESTIHL
Rollomatic E

	cm		in.		mm		in.		mm		in.		STIHL Rollomatic E		STIHL Rollomatic E		
	cm	in.	mm	in.	mm	in.	mm	in.	mm	in.	mm	in.	mm	in.	mm	in.	
STIHL 08 S	43	17	9,32	3/8	1,6	.063	66										
	53	21	9,32	3/8	1,6	.063	75										
	43	17	10,26	.404	1,6	.063	60										
	53	21	10,26	.404	1,6	.063	68										
	63	25	10,26	.404	1,6	.063	80										
STIHL 034, 036, MS 340, MS 360	32	13	8,25	.325	1,5	.058	56	3003 000 5006	11								
	37	15	8,25	.325	1,5	.058	62	3003 000 5011	11								
	32	13	8,25	.325	1,6	.063	56	3003 000 5306	11								
	37	15	8,25	.325	1,6	.063	62	3003 000 6811	11								
	40	16	8,25	.325	1,6	.063	67	3003 000 6813	11								
	45	18	8,25	.325	1,6	.063	74	3003 008 6817	11								
	50	20	8,25	.325	1,6	.063	81	3003 008 6821	11								
	32	13	9,32	3/8	1,6	.063	50	3003 000 6106	10								
	37	15	9,32	3/8	1,6	.063	56	3003 000 6111	10	3003 000 5211	11						
	40	16	9,32	3/8	1,6	.063	60	3003 000 6113	10	3003 000 5213	11						
	45	18	9,32	3/8	1,6	.063	66	3003 008 6117	10	3003 000 5217	11						
	50	20	9,32	3/8	1,6	.063	72	3003 008 6121	10	3003 000 5221	11						
	STIHL MS 341, MS 361, MS 362 MS 362 C	32	13	8,25	.325	1,5	.058	57	3003 000 5006	11							
37		15	8,25	.325	1,5	.058	64	3003 000 5011	11								
32		13	8,25	.325	1,6	.063	57	3003 000 5306	11								
37		15	8,25	.325	1,6	.063	64	3003 000 6811	11								
40		16	8,25	.325	1,6	.063	68	3003 000 6813	11								
45		18	8,25	.325	1,6	.063	75	3003 008 6817	11								
50		20	8,25	.325	1,6	.063	82	3003 008 6821	11								
32		13	9,32	3/8	1,6	.063	50	3003 000 6106	10								
37		15	9,32	3/8	1,6	.063	56	3003 000 6111	10	3003 000 5211	11						
40		16	9,32	3/8	1,6	.063	60	3003 000 6113	10	3003 000 5213	11						
45		18	9,32	3/8	1,6	.063	66	3003 008 6117	10	3003 000 5217	11						
50		20	9,32	3/8	1,6	.063	72	3003 008 6121	10	3003 000 5221	11						
STIHL 036 QS, MS 360 C-Q		32	13	8,25	.325	1,5	.058	57	3003 000 5006	11							
	37	15	8,25	.325	1,5	.058	64	3003 000 5011	11								
	32	13	8,25	.325	1,6	.063	57	3003 000 5306	11								
	37	15	8,25	.325	1,6	.063	64	3003 000 6811	11								
	40	16	8,25	.325	1,6	.063	68	3003 000 6813	11								
	45	18	8,25	.325	1,6	.063	75	3003 008 6817	11								
	50	20	8,25	.325	1,6	.063	82	3003 008 6821	11								
	32	13	9,32	3/8	1,6	.063	50	3003 000 6106	10								
	37	15	9,32	3/8	1,6	.063	56	3003 000 6111	10	3003 000 5211	11						
	40	16	9,32	3/8	1,6	.063	60	3003 000 6113	10	3003 000 5213	11						
	45	18	9,32	3/8	1,6	.063	66	3003 008 6117	10	3003 000 5217	11						
	50	20	9,32	3/8	1,6	.063	72	3003 008 6121	10	3003 000 5221	11						
	STIHL MS 361 C-Q, MS 362 C-Q	32	13	8,25	.325	1,5	.058	57	3003 000 5006	11							
37		15	8,25	.325	1,5	.058	64	3003 000 5011	11								
32		13	8,25	.325	1,6	.063	57	3003 000 5306	11								
37		15	8,25	.325	1,6	.063	64	3003 000 6811	11								
40		16	8,25	.325	1,6	.063	68	3003 000 6813	11								
45		18	8,25	.325	1,6	.063	75	3003 008 6817	11								
50		20	8,25	.325	1,6	.063	82	3003 008 6821	11								
32		13	9,32	3/8	1,6	.063	50	3003 000 6106	10								
37		15	9,32	3/8	1,6	.063	56	3003 000 6111	10	3003 000 5211	11						
40		16	9,32	3/8	1,6	.063	60	3003 000 6113	10	3003 000 5213	11						
45		18	9,32	3/8	1,6	.063	66	3003 008 6117	10	3003 000 5217	11						
50		20	9,32	3/8	1,6	.063	72	3003 008 6121	10	3003 000 5221	11						



STIHL

Rollomatic E Super



STIHL

Rollomatic E Super Light



STIHL

Rollomatic E Mini Light



STIHL

Carving E

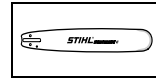

STIHL

Duromatic E

				3002 000 9215
				3002 000 9223
3002 000 9715	12			3002 000 9215
3002 000 9723	12			3002 000 9223
3002 000 9731	12			3002 000 9231
				3003 000 9211
				3003 000 9213
				3003 000 9217
				3003 000 9221
				3003 000 9211
3003 000 9413	11			3003 000 9213
3003 000 9417	11			3003 000 9217
3003 000 9421	11	3003 000 2021	11	3003 000 9221
				3003 000 9211
				3003 000 9213
				3003 000 9217
				3003 000 9221
				3003 000 9211
3003 000 9413	11			3003 000 9213
3003 000 9417	11			3003 000 9217
3003 000 9421	11			3003 000 9221
				3003 000 9211
				3003 000 9213
				3003 000 9217
				3003 000 9221
				3003 000 9211
3003 000 9413	11			3003 000 9213
3003 000 9417	11			3003 000 9217
3003 000 9421	11	3003 000 2021	11	3003 000 9221
				3003 000 9211
				3003 000 9213
				3003 000 9217
				3003 000 9221

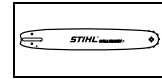
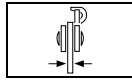
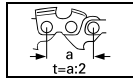
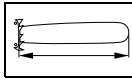

cm

in.

mm

in.

mm



in.

STIHL
Rollomatic E

STIHL
Rollomatic E

=> MS 361 C-Q, MS 362 C-Q	32	13	9,32	3/8	1,6	.063	50	3003 000 6106	10		
	37	15	9,32	3/8	1,6	.063	56	3003 000 6111	10	3003 000 5211	11
	40	16	9,32	3/8	1,6	.063	60	3003 000 6113	10	3003 000 5213	11
	45	18	9,32	3/8	1,6	.063	66	3003 008 6117	10	3003 000 5217	11
	50	20	9,32	3/8	1,6	.063	72	3003 008 6121	10	3003 000 5221	11
STIHL 038, MS 380, MS 381, MS 382	37	15	9,32	3/8	1,6	.063	56			3003 000 5211	11
	40	16	9,32	3/8	1,6	.063	60			3003 000 5213	11
	45	18	9,32	3/8	1,6	.063	66			3003 000 5217	11
	50	20	9,32	3/8	1,6	.063	72			3003 000 5221	11
	55	22	9,32	3/8	1,6	.063	76				
	63	25	9,32	3/8	1,6	.063	84	3003 000 5231	11		
	71	28	9,32	3/8	1,6	.063	91				
STIHL 044, 046, MS 440, MS 441, MS 441 C-Q MS 460 MS 461 MS 462	37	15	9,32	3/8	1,6	.063	56			3003 000 5211	11
	40	16	9,32	3/8	1,6	.063	60			3003 000 5213	11
	45	18	9,32	3/8	1,6	.063	66			3003 000 5217	11
	50	20	9,32	3/8	1,6	.063	72			3003 000 5221	11
	55	22	9,32	3/8	1,6	.063	76				
	63	25	9,32	3/8	1,6	.063	84			3003 000 5231	11
	71	28	9,32	3/8	1,3	.050	91				
	71	28	9,32	3/8	1,3	.050	91				
	71	28	9,32	3/8	1,6	.063	91				
	75	30	9,32	3/8	1,6	.063	98				
	80	32	9,32	3/8	1,3	.050	105				
	80	32	9,32	3/8	1,6	.063	105				
	90	36	9,32	3/8	1,3	.050	114				
	90	36	9,32	3/8	1,6	.063	114				
90	36	9,32	3/8	1,6	.063	114					
MS 460 R, MS 461 R MS 462 R	50	20	9,32	3/8	1,6	.063	72				

1 =  96,

2 =  9 =  81



STIHL

Rollomatic E Super



STIHL

Rollomatic E Super Light



STIHL

Rollomatic E Mini Light



STIHL

Carving E

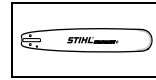

STIHL

Duromatic E

3003 000 9413	11			3003 000 9211
3003 000 9417	11			3003 000 9213
3003 000 9421	11	3003 000 2021	11	3003 000 9217
				3003 000 9221
3003 000 9413	11			3003 000 9211
3003 000 9417	11			3003 000 9213
3003 000 9421	11	3003 000 2021	11	3003 000 9217
3003 000 9425	11			3003 000 9221
3003 000 9431	11	3003 000 2031	11	3003 001 5631
3003 000 6038	11	3003 000 2038	11	
3003 000 9413	11			3003 000 9211
3003 000 9417	11			3003 000 9213
3003 000 9421	11	3003 000 2021	11	3003 000 9217
3003 000 9425	11			3003 000 9221
3003 000 9431	11	3003 000 2031	11	3003 001 5631
3003 000 8838	11	3003 000 2238	11	
3003 000 6038	11	3003 000 2038	11	
3003 000 6041	11			3003 001 9241 ¹
		3003 000 2246	11	
3003 000 6046	11	3003 000 2046	11	
3003 000 8853	11	3003 000 2253	11	
3003 000 6053	11	3003 000 2053	11	3003 000 8453
3003 002 9421	11			

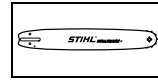
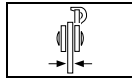
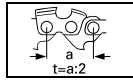
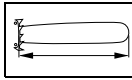

cm

in.

mm

in.

mm

in.

STIHL
Rollomatic E

STIHL
Rollomatic E

STIHL 064, 066, MS 640, MS 650, MS 651, MS 660, MS 661, MS 661 C	40	16	9,32	3/8	1,6	.063	60		3003 000 5213	11	
	45	18	9,32	3/8	1,6	.063	66		3003 000 5217	11	
	50	20	9,32	3/8	1,6	.063	72		3003 000 5221	11	
	55	22	9,32	3/8	1,6	.063	76				
	63	25	9,32	3/8	1,6	.063	84		3003 000 5231	11	
	71	28	9,32	3/8	1,3	.050	91				
	71	28	9,32	3/8	1,3	.050	91				
	71	28	9,32	3/8	1,6	.063	91				
	75	30	9,32	3/8	1,6	.063	98				
	80	32	9,32	3/8	1,3	.050	105				
	80	32	9,32	3/8	1,6	.063	105				
	90	36	9,32	3/8	1,6	.063	114				
	90	36	9,32	3/8	1,3	.050	114				
	90	36	9,32	3/8	1,6	.063	114				
	40	16	10,26	.404	1,6	.063	55				
	45	18	10,26	.404	1,6	.063	60				
	50	20	10,26	.404	1,6	.063	66				
	63	25	10,26	.404	1,6	.063	77				
	75	30	10,26	.404	1,6	.063	88				
	80	32	10,26	.404	1,6	.063	95				
	80	32	10,26	.404	1,6	.063	95				
	90	36	10,26	.404	1,6	.063	104				
064, 066, MS 640, MS 660, LOGOSOL	32	13	9,32	3/8 P	1,3	.050	66		3003 000 6306	9	
	40	16	9,32	3/8 P	1,3	.050	66		3003 000 6313	9	
	45	18	9,32	3/8 P	1,3	.050	66		3003 000 6317	9	
	50	20	9,32	3/8 P	1,3	.050	72				
	63	25	9,32	3/8 P	1,3	.050	84				
	45	18	9,32	3/8	1,6	.063	66		3003 000 5217	11	
	50	20	9,32	3/8	1,6	.063	72		3003 000 5221	11	
	63	25	9,32	3/8	1,6	.063	84		3003 000 5231	11	
	50	20	10,26	.404	1,6	.063	66				
	63	25	10,26	.404	1,6	.063	77				
STIHL 051, 076	53	21	9,32	3/8	1,6	.063	75				
	63	25	9,32	3/8	1,6	.063	88				
	75	30	9,32	3/8	1,6	.063	100				
	(076)	90	36	9,32	3/8	1,6	.063	114			
	(076)	105	41	9,32	3/8	1,6	.063	135			
	(076)	120	47	9,32	3/8	1,6	.063	152			
		43	17	10,26	.404	1,6	.063	60			
		53	21	10,26	.404	1,6	.063	68			
		63	25	10,26	.404	1,6	.063	80			
		75	30	10,26	.404	1,6	.063	91			
		80	32	10,26	.404	1,6	.063	100			
	(076)	90	36	10,26	.404	1,6	.063	108			
	(076)	90	36	10,26	.404	1,6	.063	104			
	(076)	105	41	10,26	.404	1,6	.063	123			
(076)	120	47	10,26	.404	1,6	.063	138				
(076)	150	59	10,26	.404	1,6	.063	173				



STIHL

Rollomatic E Super



STIHL

Rollomatic E Super Light



STIHL

Rollomatic E Mini Light



STIHL

Carving E

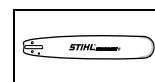

STIHL

Duromatic E

3003 000 9413	11			3003 000 9213
3003 000 9417	11			3003 000 9217
3003 000 9421	11	3003 000 2021	11	3003 000 9221
3003 000 9425	11			
3003 000 9431	13	3003 000 2031	11	3003 001 5631
3003 000 8838	11	3003 000 2238	11	
3003 000 6038	11	3003 000 2038	11	
3003 000 6041	11			3003 001 9241 ¹
3003 000 6046	11	3003 000 2246	11	
3003 000 6053	11	3003 000 2046	11	
3003 000 8853	11	3003 000 2253	11	3003 000 8453
		3003 000 2053	11	
				3003 000 9213
3003 000 9721	12			3003 000 9217
3003 000 9731	12			3003 000 9221
	10			3003 001 5631
				3003 001 9241
3003 000 7353	10			3003 000 8453
				3003 000 8621
				3003 000 5531
3003 000 9417	11			3003 000 9217
3003 000 9421	11	3003 000 2021	11	3003 000 9221
3003 000 9431	13	3003 000 2031	11	3003 001 5631
3003 000 9721	12			3003 000 9221
3003 000 9731	12			3003 001 5631
3002 000 9041	13			3002 000 8423
				3002 000 9231
				3002 000 8041
				3002 000 8052
				3002 000 8058
				3002 000 8064
3002 000 9715	12			3002 000 8423
3002 000 9723	12			3002 000 9231
3002 000 9731	12			3002 000 8041
3002 000 9741	12			3002 000 8045
3002 000 9753	12			
3002 000 9757	12			3002 000 8052
				3002 000 8058
				3002 000 8064
3002 000 9576	12			

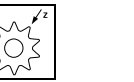
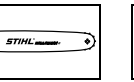
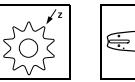
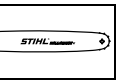
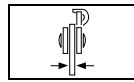
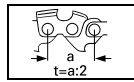
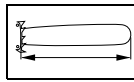

cm

in.

mm

in.

mm

in.

STIHL
Rollomatic E

STIHL
Rollomatic E

STIHL MS 780, 084, 088, MS 880	53	21	9,32	3/8	1,6	.063	75			
	63	25	9,32	3/8	1,6	.063	88			
	75	30	9,32	3/8	1,6	.063	100			
	90	36	9,32	3/8	1,6	.063	114			
	105	41	9,32	3/8	1,6	.063	135			
	120	47	9,32	3/8	1,6	.063	152			
	43	17	10,26	.404	1,6	.063	60			
	53	21	10,26	.404	1,6	.063	68			
	63	25	10,26	.404	1,6	.063	80			
	75	30	10,26	.404	1,6	.063	91			
80	32	10,26	.404	1,6	.063	100				
90	36	10,26	.404	1,6	.063	108				
90	36	10,26	.404	1,6	.063	104				
105	41	10,26	.404	1,6	.063	123				
120	47	10,26	.404	1,6	.063	138				
150	59	10,26	.404	1,6	.063	173				
STIHL 070, 090, MS 720	53	21	10,26	.404	1,6	.063	72			
	63	25	10,26	.404	1,6	.063	84			
	75	30	10,26	.404	1,6	.063	92			
	80	32	10,26	.404	1,6	.063	100			
	90	36	10,26	.404	1,6	.063	104			
	(090)	105	41	10,26	.404	1,6	.063	123		
	(090)	120	47	10,26	.404	1,6	.063	139		
	(090)	150	59	10,26	.404	1,6	.063	173		
STIHL 090 G	75	30	10,26	.404	1,6	.063	92			
	90	36	10,26	.404	1,6	.063	104			
	105	41	10,26	.404	1,6	.063	123			
STIHL MC 200	30	12	9,32	3/8 P	1,1	.043	44	3005 000 3905 ¹		
STIHL E 140, E 160, E 180, MSE 140, MSE 140 C, MSE 160, MSE 160 C, MSE 180, MSE 180 C, MSE 200, MSE 200 C	30	12	9,32	3/8 P	1,3	.050	44	3005 000 4805	9	
	35	14	9,32	3/8 P	1,3	.050	50	3005 000 4809	9	
	40	16	9,32	3/8 P	1,3	.050	55			
	40	16	9,32	3/8 P	1,3	.050	55	3005 008 4813	9	
	45	18	9,32	3/8 P	1,3	.050	61	3005 000 4817	9	
	30	12	9,32	3/8 P	1,3	.050	45 ²	3005 000 4805	9	
	35	14	9,32	3/8 P	1,3	.050	51 ²	3005 000 4809	9	
	40	16	9,32	3/8 P	1,3	.050	56 ²			
	40	16	9,32	3/8 P	1,3	.050	56 ²	3005 008 4813	9	
	45	18	9,32	3/8 P	1,3	.050	62 ²	3005 000 4817	9	
	30	12	6,35	1/4	1,3	.050	64			

1 = Rollomatic E Mini

2 =  +  Z

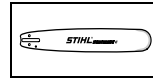
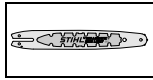

STIHL
Rollomatic E Super

STIHL
Rollomatic E Super Light

STIHL
Rollomatic E Mini Light

STIHL
Carving E

STIHL
Duromatic E

		3002 000 8423
		3002 000 9231
		3002 000 8041
		3002 000 8052
		3002 000 8058
		3002 000 8064

3002 000 9715	12	
3002 000 9723	12	3002 000 8423
3002 000 9731	12	3002 000 9231
3002 000 9741	12	3002 000 8041
		3002 000 8045
3002 000 9753	12	
		3002 000 8052
3002 000 9757	12	3002 000 8058
		3002 000 8064
3002 000 9576	12	

		3001 000 9223
		3001 000 9231
		3002 000 8041
		3002 000 8045
		3002 000 8052
		3002 000 8058
		3002 000 8064
3002 000 9576	12	

		3002 000 8041
		3002 000 8052
		3002 000 8058

--	--	--

	3005 000 7405	9
	3005 000 7409	9
	3005 000 7413	9
	3005 000 7405	9
	3005 000 7409	9
	3005 000 7413	9

3005 000 3205

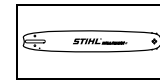
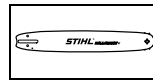
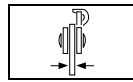
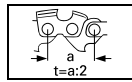
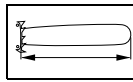

	cm	in.	mm	in.	mm	in.		STIHL Rollomatic E	STIHL Rollomatic E
⇒ MSE 160, MSE 180, MSE 200	45	18	9,32	3/8 P	1,3	.050	61	3005 000 4817	9
(MSE 140)	30	12	9,32	3/8 P	1,1	.043	45 ²	3005 000 3905 ¹	7
(E 140)	35	14	9,32	3/8 P	1,1	.043	51 ²	3005 008 3909 ¹	7
(E 140)	40	16	9,32	3/8 P	1,1	.043	56 ²	3005 008 3913 ¹	7
MSE 141 C	25	10	9,32	3/8 P	1,1	.043			
	30	12	9,32	3/8 P	1,1	.043	44	3005 000 3905 ¹	7
	35	14	9,32	3/8 P	1,1	.043	50	3005 008 3909 ¹	7
	40	16	9,32	3/8 P	1,1	.043	55	3005 008 3913 ¹	7
	30	12	9,32	3/8 P	1,3	.050	44	3005 000 4805	9
	35	14	9,32	3/8 P	1,3	.050	50	3005 000 4809	9
	40	16	9,32	3/8 P	1,3	.050	55	3005 000 4813	9
	45	18	9,32	3/8 P	1,3	.050	61	3005 000 4817	9
STIHL E 20, E 220, MSE 220	37	15	8,25	.325	1,6	.063	63	3003 000 6811	11
	40	16	8,25	.325	1,6	.063	67	3003 000 6813	11
	45	18	8,25	.325	1,6	.063	74	3003 008 6817	11
	50	20	8,25	.325	1,6	.063	81	3003 008 6821	11
	37	15	9,32	3/8	1,6	.063	57	3003 000 6111	10
	40	16	9,32	3/8	1,6	.063	60	3003 000 6113	10
	45	18	9,32	3/8	1,6	.063	66	3003 008 6117	10
	50	20	9,32	3/8	1,6	.063	72	3003 008 6121	10
STIHL MSE 170, MSE 190, MSE 210 MSE 230	30	12	9,32	3/8 P	1,1	.043	45 ²	3005 000 3905 ¹	7
	35	14	9,32	3/8 P	1,1	.043	51 ²	3005 008 3909 ¹	7
	40	16	9,32	3/8 P	1,1	.043	56 ²	3005 008 3913 ¹	7
	30	12	9,32	3/8 P	1,3	.050	44	3005 000 4805	9
	35	14	9,32	3/8 P	1,3	.050	50	3005 000 4809	9
	40	16	9,32	3/8 P	1,3	.050	55	3005 000 4813	9
	45	18	9,32	3/8 P	1,3	.050	61	3005 000 4817	9
STIHL MSE 250	37	15	9,32	3/8	1,6	.063	57	3003 000 6111	10
	40	16	9,32	3/8	1,6	.063	60	3003 000 6113	10
	45	18	9,32	3/8	1,6	.063	66	3003 008 6117	10
	50	20	9,32	3/8	1,6	.063	72	3003 008 6121	10
STIHL MSA 120 C, MSA 140 C, MSA 160 C MSA 200 C	30	12	6,35	1/4 P	1,1	.043	64	3005 008 3405 ¹	8
	35	14	6,35	1/4 P	1,1	.043	72	3005 008 3409 ¹	8
(MSA 160 C, MSA 200 C)	30	12	9,32	3/8 P	1,1	.043	44	3005 000 3905 ¹	7
STIHL MSA 160 T,	25	10	6,35	1/4 P	1,1	.043	56	3005 008 3403 ¹	8
	30	12	6,35	1/4 P	1,1	.043	64	3005 008 3405 ¹	8
STIHL MSA 161 T	25	10	6,35	1/4 P	1,1	.043	57	3005 008 3403 ¹	8
	30	12	6,35	1/4 P	1,1	.043	65	3005 008 3405 ¹	8

1 = Rollomatic E Mini

2 =  7 Z



STIHL
Rollomatic E Super



STIHL
Rollomatic E Light



STIHL
Rollomatic E Mini Light

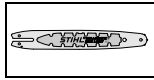

STIHL
Carving E

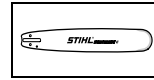

STIHL
Duromatic E

3005 000 7605 7
3005 000 7609 7

3005 000 7603 7
3005 000 7605 7
3005 000 7609 7

3005 000 7405 9
3005 000 7409 9
3005 000 7413 9

3003 000 9211
3003 000 9213
3003 000 9217
3003 000 9221

3003 000 9413 11
3003 000 9417 11
3003 000 9421 11

3003 000 9211
3003 000 9213
3003 000 9217
3003 000 9221

3005 000 7605 7
3005 000 7609 7

3005 000 7405 9
3005 000 7409 9
3005 000 7413 9

3003 000 9413 11
3003 000 9417 11
3003 000 9421 11

3003 000 9211
3003 000 9213
3003 000 9217
3003 000 9221

3005 000 3105

3005 000 3105

3005 000 3105

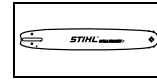
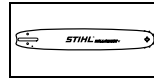
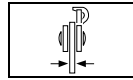
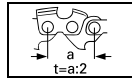
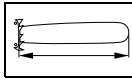

cm

in.

mm

in.

mm

in.

STIHL
Rollomatic E

STIHL
Rollomatic E

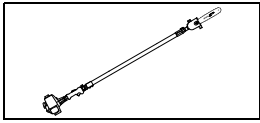

STIHL	HT 70, HT 75,	25	10	6,35	1/4 P	1,1	.043	56	3005 008 3403 ¹	8
	HT 56	30	12	6,35	1/4 P	1,1	.043	64	3005 008 3405 ¹	8
	HT 100,	35	14	6,35	1/4 P	1,1	.043	72	3005 008 3409 ¹	8
	HT 130,	30	12	9,32	3/8 P	1,1	.043	44	3005 000 3905 ¹	
	HT, HT-KM, HTE 60									
	HT 70K	30	12	9,32	3/8 P	1,3	.050	44	3005 000 4805	
	HT 121	30	12	6,35	1/4 P	1,1	.043	64	3005 008 3405 ¹	8
	HT 101, HT 131	30	12	9,32	3/8 P	1,1	.043	44	3005 000 3905 ¹	
	HT 102,	25	10	6,35	1/4 P	1,1	.043	56	3005 008 3403 ¹	8
	HT 103,	30	12	6,35	1/4 P	1,1	.043	64	3005 008 3405 ¹	8
	HT 132, HT 133,	35	14	6,35	1/4 P	1,1	.043	72	3005 008 3409 ¹	8
STIHL	HTA 65,	25	10	6,35	1/4 P	1,1	.043	56	3005 008 3403 ¹	8
	HTA 85	30	12	6,35	1/4 P	1,1	.043	64	3005 008 3405 ¹	8
		35	14	6,35	1/4 P	1,1	.043	72	3005 008 3409 ¹	8

1 = Rollomatic E Mini

2 =  +  7 Z



STIHL
Rollomatic E Super



STIHL
Rollomatic E Light

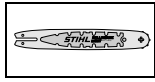

STIHL
Rollomatic E Mini Light



STIHL
Carving E

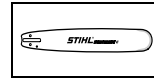

STIHL
Duromatic E

3005 000 7605 7

3005 000 3105

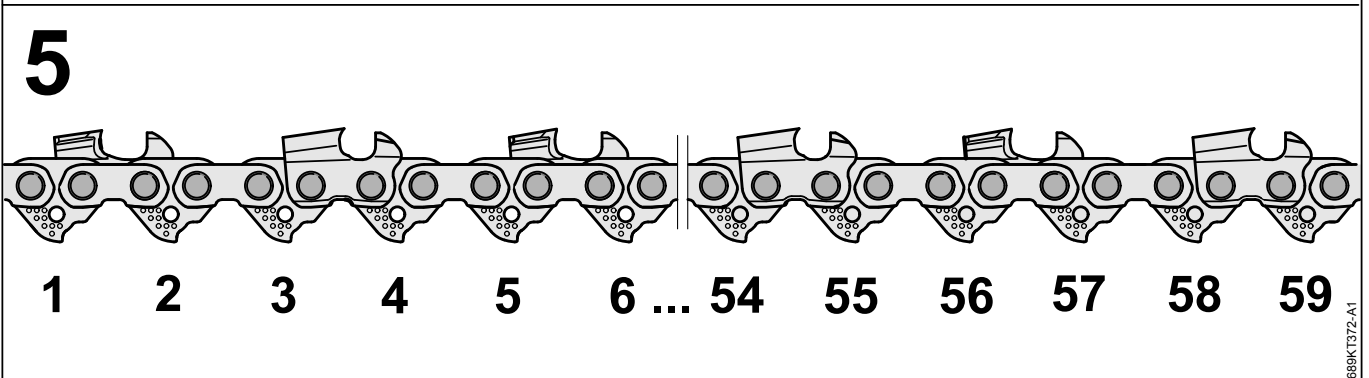
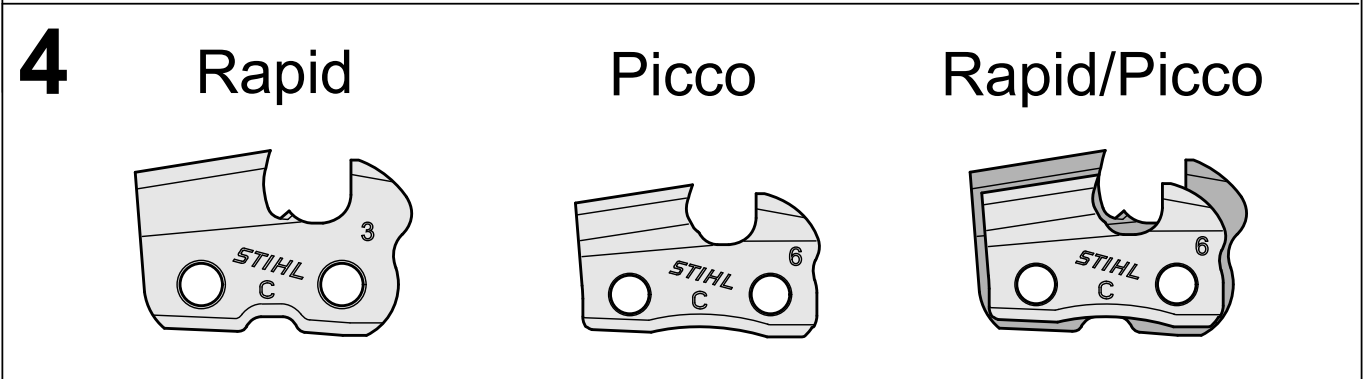
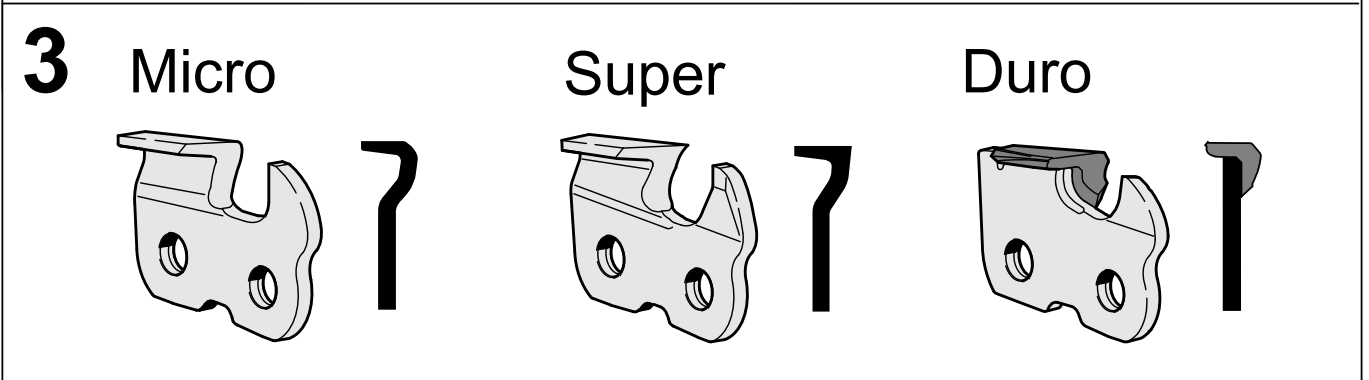
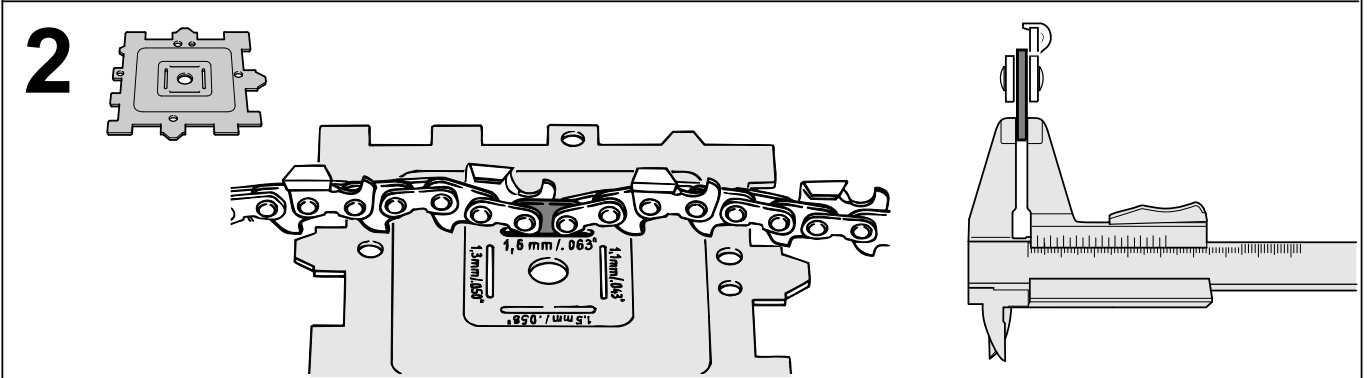
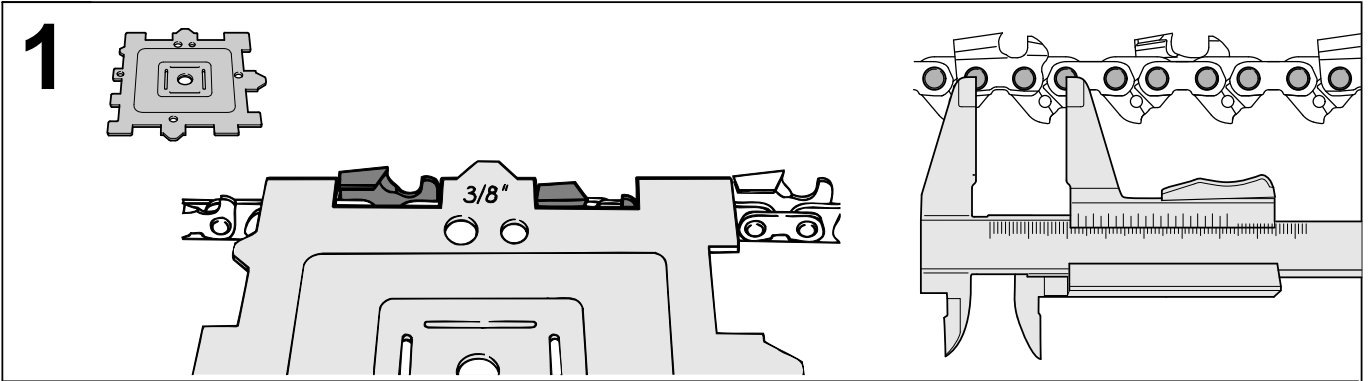



1		mm	6,35	6,35	9,32		8,25			9,32			10,26	
		in.	1/4" P	1/4"	3/8" P		.325"			3/8"			.404"	
2		mm	1,1	1,3	1,1	1,3	1,3	1,5	1,6	1,3	1,5	1,6	1,5	1,6
		in.	.043	.050	.043	.050	.050	.058	.063	.050	.058	.063	.058	.063
RAPID	Standard	RCK												3812
		RCX												3958
		RCXK												3895
	Micro	RM		3660			3684	3685	3686	3650	3651	3652		3668
		RMS		3661										
		RM3					3687	3688	3689	3662		3664		
		RMK												3860
		RMF								3654				3671
		RMX										3653		3838
	Super	RS					3637	3638	3639	3623	3622	3621		3946
		RS3								3624		3626		
		RSK								3874		3898		3846
		RSF								3676	3913	3979	3924	3911
	Duro	RD3					3665	3666	3667	3681	3682	3683		
		RDR										3944		
	PICCO	Micro	PM				3613							
			PM3	3670			3636							
			PMX				3614							
			PMY				3615							
			PMM3			3610								
Super		PS				3617								
		PS3				3616								
Duro		PD3				3612								
4		3												

10,26 mm (.404")



M 1:1

9,32 mm (3/8")
(3/8"P)



3/8" Rapid



3/8" Picco



5 →

8,25 mm (.325")



6,35 mm (1/4")
(1/4"P)



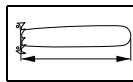

cm in.

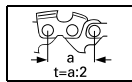

mm in.

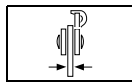

mm in.

RM

STIHL RAPID
Micro



RM3

STIHL RAPID
Micro 3

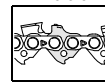

RS

STIHL RAPID
Super



AEG3632

KES35,	30	12	9,32	3/8 P	1,3	.050			
KS30, KS35, KS40	35	14	9,32	3/8 P	1,3	.050			
	40	16	9,32	3/8 P	1,3	.050			

ALKO

E1200, 1400E, 1500E,	30	12	9,32	3/8 P	1,3	.050			
2000, 2300, KB3500,	35	14	9,32	3/8 P	1,3	.050			
KB4000, KB4500,	40	16	9,32	3/8 P	1,3	.050			
KE3500									

140	30	12	8,25	.325	1,3	.050	3684 000 0055	3687 000 0055	3637 000 0055
	35	14	8,25	.325	1,3	.050	3684 000 0061	3687 000 0061	3637 000 0061

240	35	14	8,25	.325	1,3	.050	3684 000 0057	3687 000 0057	3637 000 0057
-----	----	----	------	------	-----	------	---------------	---------------	---------------

1074, P21, P26,	35	14	8,25	.325	1,5	.058	3685 000 0060	3688 000 0060	3638 000 0060
P28/S	40	16	8,25	.325	1,5	.058	3685 000 0069	3688 000 0069	3638 000 0069

3400	40	16	9,32	3/8	1,3	.050	3650 000 0059		3623 000 0059
	40	16	9,32	3/8	1,3	.050	3650 000 0060		3623 000 0060
	45	18	9,32	3/8	1,3	.050	3650 000 0064		3623 000 0064
	45	18	9,32	3/8	1,3	.050	3650 000 0066		3623 000 0066
	50	20	9,32	3/8	1,3	.050	3650 000 0069		3623 000 0069
	50	20	9,32	3/8	1,3	.050	3650 000 0070		3623 000 0070

251, 261, 460, 480	40	16	9,32	3/8	1,5	.058	3651 000 0060		3622 000 0060
	50	20	9,32	3/8	1,5	.058	3651 000 0072		3622 000 0072

P1200A, P40, P41,	40	16	9,32	3/8	1,5	.058	3651 000 0061		3622 000 0061
P51, P60, P61	50	20	9,32	3/8	1,5	.058	3651 000 0070		3622 000 0070
	60	24	9,32	3/8	1,5	.058	3651 000 0079		3622 000 0079

Farmer Saw, 170	45	18	9,32	3/8	1,5	.058	3651 000 0066		3622 000 0066
	38	15	9,32	3/8	1,6	.063	3652 000 0056	3664 000 0056	3621 000 0056
	45	18	9,32	3/8	1,6	.063	3652 000 0066	3664 000 0066	3621 000 0066
	50	20	9,32	3/8	1,6	.063	3652 000 0070	3664 000 0070	3621 000 0070

ALPINA/CASTOR

A-10E, A-14E,	30	12	9,32	3/8 P	1,3	.050			
E120, E130, E150	35	14	9,32	3/8 P	1,3	.050			
	40	16	9,32	3/8 P	1,3	.050			

330, 380, 432, 438,	30	12	9,32	3/8 P	1,3	.050			
P34	35	14	9,32	3/8 P	1,3	.050			
	35	14	9,32	3/8 P	1,3	.050			
	40	16	9,32	3/8 P	1,3	.050			
	40	16	9,32	3/8 P	1,3	.050			

45AV, A40AV, A40E,	30	12	8,25	.325	1,3	.050	3684 000 0055	3687 000 0055	3637 000 0055
C40E, CP 41, CP45,	35	14	8,25	.325	1,3	.050	3684 000 0061	3687 000 0061	3637 000 0061
PROF 41, PROF 45	40	16	8,25	.325	1,3	.050	3684 000 0065	3687 000 0065	3637 000 0065
	45	18	8,25	.325	1,3	.050	3684 000 0072	3687 000 0072	3637 000 0071

A40E, C40E, CP 41,	30	12	8,25	.325	1,5	.058	3685 000 0055	3688 000 0055	3638 000 0055
CP45, PROF 41	35	14	8,25	.325	1,5	.058	3685 000 0061	3688 000 0061	3638 000 0061
PROF 45, 540, 5401	40	16	8,25	.325	1,5	.058	3685 000 0065	3688 000 0065	3638 000 0065
ISO FLOAT	45	18	8,25	.325	1,5	.058	3685 000 0072	3688 000 0072	3638 000 0072

RS3

STIHL RAPID
Super 3

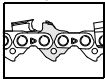

RSK

STIHL RAPID
Super K



RD3

STIHL RAPID
Duro 3

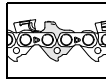

PM

STIHL PICCO
Micro



PD3

STIHL PICCO
Duro 3

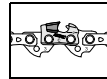

PM3

STIHL PICCO
Micro 3

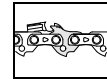

PMM3

STIHL PICCO
Micro Mini 3

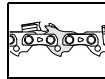

3613 000 0045	3612 000 0045	3636 000 0045
3613 000 0052	3612 000 0052	3636 000 0052
3613 000 0057	3612 000 0057	3636 000 0057

3613 000 0045	3612 000 0045	3636 000 0045
3613 000 0052	3612 000 0052	3636 000 0052
3613 000 0057	3612 000 0057	3636 000 0057

3624 000 0059	3874 000 0059	3681 000 0059
3624 000 0060	3874 000 0060	3681 000 0060
3624 000 0064	3874 000 0064	3681 000 0064
3624 000 0066	3874 000 0066	3681 000 0066
3624 000 0069	3874 000 0069	3681 000 0069
3624 000 0070	3874 000 0070	3681 000 0070

3893 000 0060
3893 000 0072

3893 000 0061
3893 000 0070
3893 000 0079

3893 000 0066

3626 000 0056	3898 000 0056	3683 000 0056
3626 000 0066	3898 000 0066	3683 000 0066
3626 000 0070	3898 000 0070	3683 000 0070

3613 000 0045	3612 000 0045	3636 000 0045
3613 000 0052	3612 000 0052	3636 000 0052
3613 000 0057	3612 000 0057	3636 000 0057

3613 000 0044	3612 000 0044	3636 000 0044
3613 000 0049	3612 000 0049	3636 000 0049
3613 000 0050	3612 000 0050	3636 000 0050
3613 000 0055	3612 000 0055	3636 000 0055
3613 000 0056	3612 000 0056	3636 000 0056

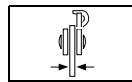
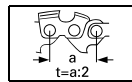
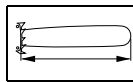

cm

in.

mm

in.

mm

in.

RM

STIHL RAPID
Micro



RM3

STIHL RAPID
Micro 3

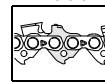

RS

STIHL RAPID
Super



=> ALPINA/CASTOR

CP55, CP65,	40	16	9,32	3/8	1,3	.050	3650 000 0059		3623 000 0059
PROF 55, PROF 65	45	18	9,32	3/8	1,3	.050	3650 000 0068		3623 000 0068
	50	20	9,32	3/8	1,3	.050	3650 000 0070		3623 000 0070
	50	20	9,32	3/8	1,3	.050	3650 000 0072		3623 000 0072
	60	24	9,32	3/8	1,3	.050	3650 000 0080		3623 000 0080

600, 600 I, ISO FLOAT,	40	16	9,32	3/8	1,5	.058	3651 000 0059		3622 000 0059
CP55, CP56, CP65,	40	16	9,32	3/8	1,5	.058	3651 000 0060		3622 000 0060
CP66,	48	19	9,32	3/8	1,5	.058	3651 000 0068		3622 000 0068
PROF 55, PROF 56,	60	24	9,32	3/8	1,5	.058	3651 000 0080		3622 000 0080
PROF 65, PROF 66									

700, 800	45	18	9,32	3/8	1,5	.058	3651 000 0068		3622 000 0068
	50	20	9,32	3/8	1,5	.058	3651 000 0072		3622 000 0072

070, 070S, A-70E,	38	15	9,32	3/8	1,6	.063	3652 000 0055	3664 000 0055	3621 000 0055
C70, C70E, C70S,	45	18	9,32	3/8	1,6	.063	3652 000 0065	3664 000 0065	3621 000 0065
CP70, PROF 70E,	50	20	9,32	3/8	1,6	.063	3652 000 0069	3664 000 0069	3621 000 0069
CP90, CP120,									
PROF 90, PROF 120	53	21	10,26	.404	1,6	.063	3668 000 0071		3946 000 0071
	63	25	10,26	.404	1,6	.063	3668 000 0082		3946 000 0082
	75	30	10,26	.404	1,6	.063	3668 000 0094		3946 000 0094
	90	36	10,26	.404	1,6	.063	3668 000 0107		3946 000 0107

BELL									
PICKPINE 16,	30	12	9,32	3/8 P	1,3	.050			
PICKPINE 34,	35	14	9,32	3/8 P	1,3	.050			
PICKPINE 38	40	16	9,32	3/8 P	1,3	.050			

BERNARD									
BM225.3, BM230.0,	30	12	9,32	3/8 P	1,3	.050			
BM230.1, BM236.3,	35	14	9,32	3/8 P	1,3	.050			
BM441.3, BM441.5	40	16	9,32	3/8 P	1,3	.050			
BM646.3, BM651.3,	40	16	9,32	3/8	1,3	.050	3650 000 0060		3623 000 0060
BM751.3	45	18	9,32	3/8	1,3	.050	3650 000 0066		3623 000 0066
	50	20	9,32	3/8	1,3	.050	3650 000 0070		3623 000 0070

BLACK & DECKER									
DN301, DN302	25	10	9,32	3/8 P	1,3	.050			
	30	12	9,32	3/8 P	1,3	.050			

CS30, CS35, DN400,	25	10	9,32	3/8 P	1,3	.050			
DN401, DN402,	30	12	9,32	3/8 P	1,3	.050			
DN404, DN412,	35	14	9,32	3/8 P	1,3	.050			
DN416, GK300,	40	16	9,32	3/8 P	1,3	.050			
GK310, GK320,									
GK321, GK322,									
GK330, GK331,									
GK430, GK435,									
GK440, GK535,									
GK540, GK1440,									
GK1630T, GK1635T,									
GK1640T									

BLITZ									
B34, B35D, B38,	30	12	9,32	3/8 P	1,3	.050			
B300, B304,	35	14	9,32	3/8 P	1,3	.050			
B400, B404, E140F	40	16	9,32	3/8 P	1,3	.050			

RS3

STIHL RAPID
Super 3



RSK

STIHL RAPID
Super K



RD3

STIHL RAPID
Duro 3

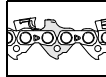

PM

STIHL PICCO
Micro



PD3

STIHL PICCO
Duro 3

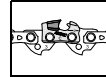

PM3

STIHL PICCO
Micro 3

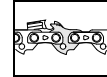

PMM3

STIHL PICCO
Micro Mini 3

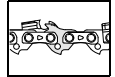

3624 000 0059	3874 000 0059	3681 000 0059
3624 000 0068	3874 000 0068	3681 000 0068
3624 000 0070	3874 000 0070	3681 000 0070
3624 000 0072	3874 000 0072	3681 000 0072
3624 000 0080	3874 000 0080	3681 000 0080

3893 000 0059
3893 000 0060
3893 000 0068
3893 000 0080

3893 000 0068
3893 000 0072

3626 000 0055	3898 000 0055	3683 000 0055
3626 000 0065	3898 000 0065	3683 000 0065
3626 000 0069	3898 000 0069	3683 000 0069

3846 000 0071
3846 000 0082
3846 000 0094
3846 000 0107

3613 000 0044	3612 000 0044	3636 000 0044
3613 000 0049	3612 000 0049	3636 000 0049
3613 000 0055	3612 000 0055	3636 000 0055

3613 000 0045	3612 000 0045	3636 000 0045
3613 000 0052	3612 000 0052	3636 000 0052
3613 000 0057	3612 000 0057	3636 000 0057

3624 000 0060	3874 000 0060	3681 000 0060
3624 000 0066	3874 000 0066	3681 000 0066
3624 000 0070	3874 000 0070	3681 000 0070

3613 000 0039	3612 000 0039	3636 000 0039
3613 000 0045	3612 000 0045	3636 000 0045

3613 000 0038	3612 000 0038	3636 000 0038
3613 000 0044	3612 000 0044	3636 000 0044
3613 000 0049	3612 000 0049	3636 000 0049
3613 000 0056	3612 000 0055	3636 000 0056

3613 000 0044	3612 000 0044	3636 000 0044
3613 000 0049	3612 000 0049	3636 000 0049
3613 000 0055	3612 000 0055	3636 000 0055

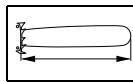

cm in.

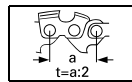

mm in.

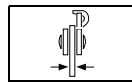

mm in.

RM

STIHL RAPID
Micro



RM3

STIHL RAPID
Micro 3

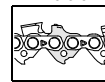

RS

STIHL RAPID
Super



=> BLITZ

B42, B45A, B46, B51, B54A	28	11	8,25	.325	1,5	.058	3685 000 0052	3688 000 0052	3638 000 0052
	33	13	8,25	.325	1,5	.058	3685 000 0056	3688 000 0056	3638 000 0056
	35	14	8,25	.325	1,5	.058	3685 000 0060	3688 000 0060	3638 000 0060
	38	15	8,25	.325	1,5	.058	3685 000 0064	3688 000 0064	3638 000 0064
	40	16	8,25	.325	1,5	.058	3685 000 0066	3688 000 0066	3638 000 0066
	43	17	8,25	.325	1,5	.058	3685 000 0068	3688 000 0068	3638 000 0068
	45	18	8,25	.325	1,5	.058	3685 000 0072	3688 000 0072	3638 000 0072
	50	20	8,25	.325	1,5	.058	3685 000 0078	3688 000 0078	3638 000 0078
B50, B500, B501S, B502, B504, B52, B55, B60, B600, B64, B701, B702, B80, B800, B802, B804, B600, B701, B702	38	15	9,32	3/8	1,5	.058	3651 000 0056		3622 000 0056
	40	16	9,32	3/8	1,5	.058	3651 000 0060		3622 000 0060
	45	18	9,32	3/8	1,5	.058	3651 000 0068		3622 000 0068
	50	20	9,32	3/8	1,5	.058	3651 000 0072		3622 000 0072
	58	23	9,32	3/8	1,5	.058	3651 000 0080		3622 000 0080
	40	16	10,26	.404	1,5	.058			3924 000 0055
	45	18	10,26	.404	1,5	.058			3924 000 0062
	50	20	10,26	.404	1,5	.058			3924 000 0066
	58	23	10,26	.404	1,5	.058			3924 000 0073
B100, B100F	53	21	10,26	.404	1,6	.063	3668 000 0068		3946 000 0068
	63	25	10,26	.404	1,6	.063	3668 000 0080		3946 000 0080

BOSCH

1586.7, 1586.8, PKE40B, AKE30B, AKE35B, AKE40B, GKE35BC, GKE40BC, PKE25, PKE30B, PKE35B	30	12	9,32	3/8 P	1,3	.050			
	35	14	9,32	3/8 P	1,3	.050			
	40	16	9,32	3/8 P	1,3	.050			

BULLCRAFT

BES1300B, KS400S, KS40S, KSE1300B, KSE30	30	12	9,32	3/8 P	1,3	.050			
	35	14	9,32	3/8 P	1,3	.050			
	40	16	9,32	3/8 P	1,3	.050			
KS450	38	15	8,25	.325	1,3	.050	3684 000 0066	3687 000 0066	3637 000 0066
	40	16	8,25	.325	1,3	.050	3684 000 0065	3687 000 0065	3637 000 0065
	40	16	8,25	.325	1,3	.050	3684 000 0066	3687 000 0066	3637 000 0066
	43	17	8,25	.325	1,3	.050	3684 000 0072	3687 000 0072	3637 000 0072
	45	18	8,25	.325	1,3	.050	3684 000 0072	3687 000 0072	3637 000 0072

DANARM

1-36 MARK II, 1-36 MARK III, 1-36 MARK IV	30	12	9,32	3/8 P	1,3	.050			
	35	14	9,32	3/8 P	1,3	.050			
	40	16	9,32	3/8 P	1,3	.050			
1-71SS, 1-93SS, 55 MARK I, 55 MARK II, 55 MARK III, 70, FRONTIER SR	40	16	9,32	3/8	1,5	.058	3651 000 0060		3622 000 0060
	50	20	9,32	3/8	1,5	.058	3651 000 0072		3622 000 0072
	60	24	9,32	3/8	1,5	.058	3651 000 0081		3622 000 0081
	70	28	9,32	3/8	1,5	.058	3651 000 0093		3622 000 0093
	80	32	9,32	3/8	1,5	.058	3651 000 0105		3622 000 0105
110, 110 AUTO, 125, 125 AUTO	40	16	10,26	.404	1,6	.063	3668 000 0056		3946 000 0056
	50	20	10,26	.404	1,6	.063	3668 000 0064		3946 000 0064
	60	24	10,26	.404	1,6	.063	3668 000 0072		3946 000 0072
	70	28	10,26	.404	1,6	.063	3668 000 0084		3946 000 0084
	80	32	10,26	.404	1,6	.063	3668 000 0100		3946 000 0100

RS3

STIHL RAPID
Super 3

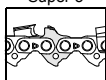

RSK

STIHL RAPID
Super K



RD3

STIHL RAPID
Duro 3

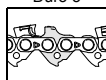

PM

STIHL PICCO
Micro



PD3

STIHL PICCO
Duro 3

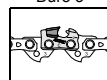

PM3

STIHL PICCO
Micro 3

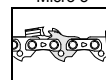

PMM3

STIHL PICCO
Micro Mini 3

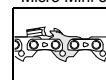

3893 000 0056
3893 000 0060
3893 000 0068
3893 000 0072
3893 000 0080

3846 000 0068
3846 000 0080

3613 000 0045	3612 000 0045	3636 000 0045
3613 000 0052	3612 000 0052	3636 000 0052
3613 000 0057	3612 000 0057	3636 000 0057

3613 000 0044	3612 000 0044	3636 000 0044
3613 000 0049	3612 000 0049	3636 000 0049
3613 000 0055	3612 000 0055	3636 000 0055

3613 000 0045	3612 000 0045	3636 000 0045
3613 000 0052	3612 000 0052	3636 000 0052
3613 000 0056	3612 000 0056	3636 000 0056

3893 000 0060
3893 000 0072
3893 000 0081
3893 000 0093
3893 000 0105

3846 000 0056
3846 000 0064
3846 000 0072
3846 000 0084
3846 000 0100

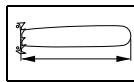

cm in.

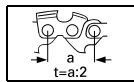

mm in.

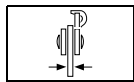

mm in.

RM

STIHL RAPID
Micro



RM3

STIHL RAPID
Micro 3

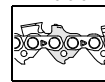

RS

STIHL RAPID
Super



DOLMAR

100, 100 S, 102,	30	12	9,32	3/8 P	1,3	.050			
103, 105, 108,	30	12	9,32	3/8 P	1,3	.050			
275, 285, 295, P533,	35	14	9,32	3/8 P	1,3	.050			
ES-140, ES-160,	40	16	9,32	3/8 P	1,3	.050			
ES-1600, PS330,	40	16	9,32	3/8 P	1,3	.050			
PS340, PS341, PS344,									
PS350, PS400, PS401									
290	35	14	9,32	3/8 P	1,3	.050			
105, 108, 110, 111, 112	33	13	8,25	.325	1,3	.050	3684 000 0056	3687 000 0056	3637 000 0056
113, 114, 115, 117, 119	38	15	8,25	.325	1,3	.050	3684 000 0064	3687 000 0064	3637 000 0064
120, 219, 410, 411,	45	18	8,25	.325	1,3	.050	3684 000 0072	3687 000 0072	3637 000 0072
5000, ES1800, PS420									
PS500C	38	15	8,25	.325	1,3	.050	3684 000 0064	3687 000 0064	3637 000 0064
	45	18	8,25	.325	1,3	.050	3684 000 0072	3687 000 0072	3637 000 0072
	38	15	8,25	.325	1,5	.058	3685 000 0064	3688 000 0064	3638 000 0064
	45	18	8,25	.325	1,5	.058	3685 000 0072	3688 000 0072	3638 000 0072
PS5105C	33	13	8,25	.325	1,3	.050	3684 000 0056	3687 000 0056	3637 000 0056
	38	15	8,25	.325	1,3	.050	3684 000 0064	3687 000 0064	3637 000 0064
	45	18	8,25	.325	1,3	.050	3684 000 0072	3687 000 0072	3637 000 0072
	53	21	8,25	.325	1,3	.050	3684 000 0078	3687 000 0078	3637 000 0078
	33	13	8,25	.325	1,5	.058	3685 000 0056	3688 000 0056	3638 000 0056
	38	15	8,25	.325	1,5	.058	3685 000 0064	3688 000 0064	3638 000 0064
	45	18	8,25	.325	1,5	.058	3685 000 0072	3688 000 0072	3638 000 0072
	53	21	8,25	.325	1,5	.058	3685 000 0078	3688 000 0078	3638 000 0078
105, 108, 110,	28	11	8,25	.325	1,5	.058	3685 000 0052	3688 000 0052	3638 000 0052
111, 112, 113,	33	13	8,25	.325	1,5	.058	3685 000 0056	3688 000 0056	3638 000 0056
114, 115, 116, 117,	35	14	8,25	.325	1,5	.058	3685 000 0060	3688 000 0060	3638 000 0060
119, 120, 219, 410, 411,	38	15	8,25	.325	1,5	.058	3685 000 0064	3688 000 0064	3638 000 0064
5000, ES1800	43	17	8,25	.325	1,5	.058	3685 000 0068	3688 000 0068	3638 000 0068
PS4600, PS5000	45	18	8,25	.325	1,5	.058	3685 000 0072	3688 000 0072	3638 000 0072
	50	20	8,25	.325	1,5	.058	3685 000 0078	3688 000 0078	3638 000 0078
PS32	30	12	9,32	3/8 P	1,1	.043			
	35	14	9,32	3/8 P	1,1	.043			
	40	16	9,32	3/8 P	1,1	.050			
PS32	30	12	9,32	3/8	1,3	.050			
PS32, PS35	35	14	9,32	3/8	1,3	.050			
PS32, PS35	40	16	9,32	3/8	1,3	.050			
PS500C	38	15	9,32	3/8	1,5	.058	3651 000 0056		3622 000 0056
	45	18	9,32	3/8	1,5	.058	3651 000 0064		3622 000 0064
PS5105C	33	13	9,32	3/8	1,5	.058	3651 000 0052		3622 000 0052
	38	15	9,32	3/8	1,5	.058	3651 000 0056		3622 000 0056
	45	18	9,32	3/8	1,5	.058	3651 000 0064		3622 000 0064
	53	21	9,32	3/8	1,5	.058	3651 000 0072		3622 000 0072
PS7310, PS7910	38	15	9,32	3/8	1,5	.058	3651 000 0056		3622 000 0056
	45	18	9,32	3/8	1,5	.058	3651 000 0064		3622 000 0064
	50	20	9,32	3/8	1,5	.058	3651 000 0072		3622 000 0072
	60	24	9,32	3/8	1,5	.058	3651 000 0080		3622 000 0080
	70	28	9,32	3/8	1,5	.058	3651 000 0096		3622 000 0096

RS3

STIHL RAPID
Super 3

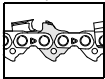

RSK

STIHL RAPID
Super K



RD3

STIHL RAPID
Duro 3

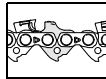

PM

STIHL PICCO
Micro



PD3

STIHL PICCO
Duro 3

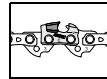

PM3

STIHL PICCO
Micro 3

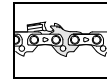

PMM3

STIHL PICCO
Micro Mini 3

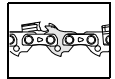

3613 000 0045	3612 000 0045	3636 000 0045
3613 000 0046	3612 000 0046	3636 000 0046
3613 000 0052	3612 000 0052	3636 000 0052
3613 000 0056	3612 000 0056	3636 000 0056
3613 000 0057	3612 000 0057	3636 000 0057

3613 000 0052	3612 000 0052	3636 000 0052
---------------	---------------	---------------

3610 000 0045
3610 000 0052
3610 000 0057

3613 000 0045	3612 000 0045	3636 000 0045
3613 000 0052	3612 000 0052	3636 000 0052
3613 000 0057	3612 000 0057	3636 000 0057

3893 000 0056
3893 000 0064

3893 000 0052
3893 000 0056
3893 000 0064
3893 000 0072

3893 000 0056
3893 000 0064
3893 000 0072
3893 000 0080
3893 000 0096

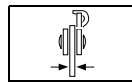
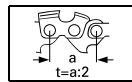
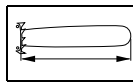

RM STIHL RAPID Micro



RM3 STIHL RAPID Micro 3

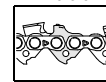

RS STIHL RAPID Super



=> DOLMAR

109, 111, 112, 114-117,	38	15	9,32	3/8	1,5	.058	3651 000 0056		3622 000 0056
119, 120, 122, 123, 133,	43	17	9,32	3/8	1,5	.058	3651 000 0064		3622 000 0064
143, 219, 1231, PS4600,	45	18	9,32	3/8	1,5	.058	3651 000 0064		3622 000 0064
PS5000, PS6000i,	50	20	9,32	3/8	1,5	.058	3651 000 0072		3622 000 0072
PS6400i, PS6800i	53	21	9,32	3/8	1,5	.058	3651 000 0072		3622 000 0072
116SI, 120SI, CA,	38	15	9,32	3/8	1,5	.058	3651 000 0056		3622 000 0056
KMS4, PS6400,	43	17	9,32	3/8	1,5	.058	3651 000 0064		3622 000 0064
PS7300, PS7900	50	20	9,32	3/8	1,5	.058	3651 000 0072		3622 000 0072
PS9000, PS9010	53	21	9,32	3/8	1,5	.058	3651 000 0072		3622 000 0072
122, 123, 133, 143,	43	17	9,32	3/8	1,5	.058	3651 000 0064		3622 000 0064
CA, KMS4, PS9000	53	21	9,32	3/8	1,5	.058	3651 000 0072		3622 000 0072
	58	23	9,32	3/8	1,5	.058	3651 000 0080		3622 000 0080
	74	29	9,32	3/8	1,5	.058	3651 000 0096		3622 000 0096
144, 153, 166 PD,	43	17	10,26	.404	1,6	.063	3668 000 0061		3946 000 0061
CA, CC, CT, DD217	53	21	10,26	.404	1,6	.063	3668 000 0070		3946 000 0070

DYNAMAC

30F, 35F,	30	12	9,32	3/8 P	1,3	.050			
E140F, DY 17E,	35	14	9,32	3/8 P	1,3	.050			
DY 36	40	16	9,32	3/8 P	1,3	.050			
45F	28	11	8,25	.325	1,5	.058	3685 000 0052	3688 000 0052	3638 000 0052
	33	13	8,25	.325	1,5	.058	3685 000 0056	3688 000 0056	3638 000 0056
	35	14	8,25	.325	1,5	.058	3685 000 0060	3688 000 0060	3638 000 0060
	38	15	8,25	.325	1,5	.058	3685 000 0064	3688 000 0064	3638 000 0064
	43	17	8,25	.325	1,5	.058	3685 000 0068	3688 000 0068	3638 000 0068
	45	18	8,25	.325	1,5	.058	3685 000 0072	3688 000 0072	3638 000 0072
	50	20	8,25	.325	1,5	.058	3685 000 0078	3688 000 0078	3638 000 0078
55 DELUXE,	40	16	9,32	3/8	1,5	.058	3651 000 0060		3622 000 0060
DY 56, DY 62	45	18	9,32	3/8	1,5	.058	3651 000 0068		3622 000 0068
	50	20	9,32	3/8	1,5	.058	3651 000 0072		3622 000 0072
	58	23	9,32	3/8	1,5	.058	3651 000 0080		3622 000 0080

DYNAMARK

4201, 4221, 4222,	30	12	9,32	3/8 P	1,3	.050			
4223, 4241, 4242,	35	14	9,32	3/8 P	1,3	.050			
4244, 4245									
4221, 4222	40	16	9,32	3/8	1,3	.050	3650 000 0060		3623 000 0060
	45	18	9,32	3/8	1,3	.050	3650 000 0066		3623 000 0066
	50	20	9,32	3/8	1,3	.050	3650 000 0070		3623 000 0070

ECHO

CS-280E, CS-304VL,	25	10	6,35	1/4	1,3	.050	3660 000 0056		
CS-351VL, CS-280EG,	30	12	6,35	1/4	1,3	.050	3660 000 0066		
CS-302, CS-280EVL	35	14	6,35	1/4	1,3	.050	3660 000 0076		
CS-280E, CS-285EVL,	30	12	9,32	3/8 P	1,3	.050			
CS-290EVL,	30	12	9,32	3/8 P	1,3	.050			
CS-300EVL, CS-302,	35	14	9,32	3/8 P	1,3	.050			
CS-310, CS-310ES,	35	14	9,32	3/8 P	1,3	.050			
CS-315, CS-320EVL,	40	16	9,32	3/8 P	1,3	.050			
CS-328, CS-330EVL,									
CS-360EVL, E155,									
CS-2000, CS-2800,									
CS-2900, CS-3050,									
CS-310ES, CS-3450,									
CS-3500, CS-4400,									
ECS150/1850T									
CS-2600, CS 3000,									

RS3

STIHL RAPID
Super 3



RSK

STIHL RAPID
Super K



RD3

STIHL RAPID
Duro 3

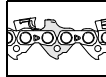

PM

STIHL PICCO
Micro



PD3

STIHL PICCO
Duro 3



PM3

STIHL PICCO
Micro 3

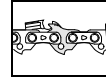

PMM3

STIHL PICCO
Micro Mini 3

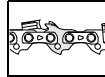

3893 000 0056
3893 000 0064
3893 000 0064
3893 000 0072
3893 000 0072

3893 000 0056
3893 000 0064
3893 000 0072
3893 000 0072

3893 000 0064
3893 000 0072
3893 000 0080
3893 000 0096

3846 000 0061
3846 000 0070

3613 000 0044 3612 000 0044 3636 000 0044
3613 000 0049 3612 000 0049 3636 000 0049
3613 000 0055 3612 000 0055 3636 000 0055

3893 000 0060
3893 000 0068
3893 000 0072
3893 000 0080

3613 000 0045 3612 000 0045 3636 000 0045
3613 000 0052 3612 000 0052 3636 000 0052

3624 000 0060 3874 000 0060 3681 000 0060
3624 000 0066 3874 000 0066 3681 000 0066
3624 000 0070 3874 000 0070 3681 000 0070

3613 000 0045 3612 000 0045 3636 000 0045
3613 000 0047 3612 000 0047 3636 000 0047
3613 000 0052 3612 000 0052 3636 000 0052
3613 000 0053 3612 000 0053 3636 000 0053
3613 000 0057 3612 000 0057 3636 000 0057

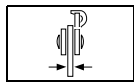
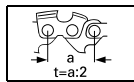
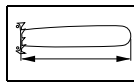

RM
STIHL RAPID
Micro



RM3
STIHL RAPID
Micro 3

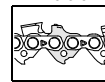

RS
STIHL RAPID
Super



=> ECHO

CS-3700, CS 3900,	33	13	8,25	.325	1,3	.050	3684 000 0056	3687 000 0056	3637 000 0056
CS-4000, CS-4200,	35	14	8,25	.325	1,3	.050	3684 000 0061	3687 000 0061	3637 000 0061
CS-400EVL,	38	15	8,25	.325	1,3	.050	3684 000 0064	3687 000 0064	3637 000 0064
CS-440EVL,	40	16	8,25	.325	1,3	.050	3684 000 0066	3687 000 0066	3637 000 0066
CS-440EVLH, CS-4610,	45	18	8,25	.325	1,3	.050	3684 000 0072	3687 000 0072	3637 000 0072
CS-5000, CD-4500									

CS-5500	40	16	8,25	.325	1,5	.058	3685 000 0067	3688 000 0067	3638 000 0067
	45	18	8,25	.325	1,5	.058	3685 000 0072	3688 000 0072	3638 000 0072

CS-3600, CS-360EVL,	33	13	8,25	.325	1,5	.058	3685 000 0056	3688 000 0056	3638 000 0056
CS-4000, CS-400EVL,	35	14	8,25	.325	1,5	.058	3685 000 0061	3688 000 0061	3638 000 0061
CS-4200, CS-4400,	38	15	8,25	.325	1,5	.058	3685 000 0064	3688 000 0064	3638 000 0064
CS-440EVL, CS-4500,	40	16	8,25	.325	1,5	.058	3685 000 0066	3688 000 0066	3638 000 0066
CS-4510, CS-4600	45	18	8,25	.325	1,5	.058	3685 000 0072	3688 000 0072	3638 000 0072
CS-490									

CS-451VL, CS-452VL,	33	13	9,32	3/8	1,3	.050	3650 000 0052		3623 000 0052
CS-500EVL, CS-500VL,	38	15	9,32	3/8	1,3	.050	3650 000 0056		3623 000 0056
CS-510EVL,	40	16	9,32	3/8	1,3	.050	3650 000 0059		3623 000 0059
CS-550EVL,	40	16	9,32	3/8	1,3	.050	3650 000 0060		3623 000 0060
CD-600ES,	45	18	9,32	3/8	1,3	.050	3650 000 0064		3623 000 0064
CS-602VL, CS-60S,	50	20	9,32	3/8	1,3	.050	3650 000 0069		3623 000 0069
CS-650EVL,	50	20	9,32	3/8	1,3	.050	3650 000 0070		3623 000 0070
CS-660EVL,	60	24	9,32	3/8	1,3	.050	3650 000 0081		3623 000 0081

CS-6700, CS-702VL,									
CS-750EVL,	33	13	9,32	3/8	1,5	.058	3651 000 0052		3622 000 0052
CS-750VL, CS-8000,	38	15	9,32	3/8	1,5	.058	3651 000 0056		3622 000 0056
CST-600EVL,	40	16	9,32	3/8	1,5	.058	3651 000 0059		3622 000 0059
CST-610EVL, CS6701	40	16	9,32	3/8	1,5	.058	3651 000 0060		3622 000 0060
	45	18	9,32	3/8	1,5	.058	3651 000 0064		3622 000 0064
	50	20	9,32	3/8	1,5	.058	3651 000 0070		3622 000 0070
	50	20	9,32	3/8	1,5	.058	3651 000 0072		3622 000 0072
	60	24	9,32	3/8	1,5	.058	3651 000 0081		3622 000 0081

CS-900EVL	43	17	10,26	.404	1,6	.063	3668 000 0062		3946 000 0062
	53	21	10,26	.404	1,6	.063	3668 000 0072		3946 000 0072
	63	25	10,26	.404	1,6	.063	3668 000 0082		3946 000 0082
	75	30	10,26	.404	1,6	.063	3668 000 0092		3946 000 0092

CS-1100VL, CS-1200	53	21	10,26	.404	1,6	.063	3668 000 0072		3946 000 0072
	63	25	10,26	.404	1,6	.063	3668 000 0084		3946 000 0084

Efco

162	38	15	8,25	.325	1,5	.058	3685 000 0064	3688 000 0064	3638 000 0064
	40	16	8,25	.325	1,5	.058	3685 000 0066	3688 000 0066	3638 000 0066
	45	18	8,25	.325	1,5	.058	3685 000 0072	3688 000 0072	3638 000 0072
	51	20	8,25	.325	1,5	.058	3685 000 0078	3688 000 0078	3638 000 0078

	41	16	9,32	3/8	1,5	.058	3651 000 0060		3622 000 0060
	45	18	9,32	3/8	1,5	.058	3651 000 0068		3622 000 0068
	51	20	9,32	3/8	1,5	.058	3651 000 0072		3622 000 0072
	56	22	9,32	3/8	1,5	.058	3651 000 0077		3622 000 0077

MT8200	51	20	9,32	3/8	1,3	.050	3650 000 0072		3623 000 0072
	61	24	9,32	3/8	1,3	.050	3650 000 0084		3623 000 0084
	71	28	9,32	3/8	1,3	.050	3650 000 0092		3623 000 0092

	51	20	9,32	3/8	1,5	.058	3651 000 0072		3622 000 0072
	61	24	9,32	3/8	1,5	.058	3651 000 0084		3622 000 0084
	71	28	9,32	3/8	1,5	.058	3651 000 0092		3622 000 0092

RS3

STIHL RAPID
Super 3

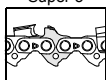

RSK

STIHL RAPID
Super K



RD3

STIHL RAPID
Duro 3

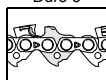

PM

STIHL PICCO
Micro



PD3

STIHL PICCO
Duro 3

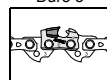

PM3

STIHL PICCO
Micro 3

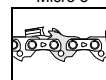

PMM3

STIHL PICCO
Micro Mini 3

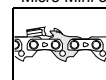

3624 000 0052	3874 000 0052	3681 000 0052
3624 000 0056	3874 000 0056	3681 000 0056
3624 000 0059	3874 000 0059	3681 000 0059
3624 000 0060	3874 000 0060	3681 000 0060
3624 000 0064	3874 000 0064	3681 000 0064
3624 000 0069	3874 000 0069	3681 000 0069
3624 000 0070	3874 000 0070	3681 000 0070
3624 000 0081	3874 000 0081	3681 000 0081

3893 000 0052
3893 000 0056
3893 000 0059
3893 000 0060
3893 000 0064
3893 000 0070
3893 000 0072
3893 000 0081

3846 000 0062
3846 000 0072
3846 000 0082
3846 000 0092

3846 000 0072
3846 000 0084

3893 000 0060
3893 000 0068
3893 000 0072
3893 000 0077

3893 000 0072
3893 000 0084
3893 000 0092

3893 000 0072
3893 000 0084
3893 000 0092

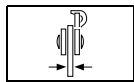
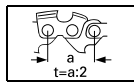
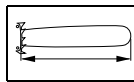

RM STIHL RAPID Micro



RM3 STIHL RAPID Micro 3

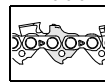

RS STIHL RAPID Super



EINHELL

EKS 25, EKS 35	25	10	9,32	3/8 P	1,3	.050			
	30	12	9,32	3/8 P	1,3	.050			
	35	14	9,32	3/8 P	1,3	.050			
	40	16	9,32	3/8 P	1,3	.050			

40A, 41, MKS 30, MKS 40AV	30	12	9,32	3/8 P	1,3	.050			
	35	14	9,32	3/8 P	1,3	.050			
	40	16	9,32	3/8 P	1,3	.050			

PES30/2, PES34/2, PES34/3, PES35, PES35/2TS, PES35/3, PES35/3TS, PES40/3, PKS35/1AV, PKS40/1AV, PROFI, KSE1435, KSE1635, KSE1640, KSE2000, PKS1635, PKS1840	30	12	9,32	3/8 P	1,3	.050			
	35	14	9,32	3/8 P	1,3	.050			
	40	16	9,32	3/8 P	1,3	.050			

PKS45/1AV, PKS50/1AV	28	11	8,25	.325	1,5	.058	3685 000 0052	3688 000 0052	3638 000 0052
	33	13	8,25	.325	1,5	.058	3685 000 0056	3688 000 0056	3638 000 0056
	35	14	8,25	.325	1,5	.058	3685 000 0060	3688 000 0060	3638 000 0060
	38	15	8,25	.325	1,5	.058	3685 000 0064	3688 000 0064	3638 000 0064
	40	16	8,25	.325	1,5	.058	3685 000 0066	3688 000 0066	3638 000 0066
	43	17	8,25	.325	1,5	.058	3685 000 0068	3688 000 0068	3638 000 0068
	45	18	8,25	.325	1,5	.058	3685 000 0072	3688 000 0072	3638 000 0072
	50	20	8,25	.325	1,5	.058	3685 000 0078	3688 000 0078	3638 000 0078

ESPER

SS-300, SS360	30	12	9,32	3/8 P	1,3	.050			
	35	14	9,32	3/8 P	1,3	.050			
	40	16	9,32	3/8 P	1,3	.050			

FESTO

ZKS30	35	14	8,25	.325	1,3	.050	3684 000 0061	3687 000 0061	3637 000 0061
	35	14	9,32	3/8	1,3	.050	3650 000 0054		3623 000 0054

FOLUX

E140F, F130, F140, F2, F3, F30, F35, F4, F41	30	12	9,32	3/8 P	1,3	.050			
	35	14	9,32	3/8 P	1,3	.050			
	40	16	9,32	3/8 P	1,3	.050			

F150, F155, F40, F42, F46, F51	28	11	8,25	.325	1,5	.058	3685 000 0052	3688 000 0052	3638 000 0052
	33	13	8,25	.325	1,5	.058	3685 000 0056	3688 000 0056	3638 000 0056
	35	14	8,25	.325	1,5	.058	3685 000 0060	3688 000 0060	3638 000 0060
	38	15	8,25	.325	1,5	.058	3685 000 0064	3688 000 0064	3638 000 0064
	40	16	8,25	.325	1,5	.058	3685 000 0066	3688 000 0066	3638 000 0066
	43	17	8,25	.325	1,5	.058	3685 000 0068	3688 000 0068	3638 000 0068
	45	18	8,25	.325	1,5	.058	3685 000 0072	3688 000 0072	3638 000 0072
	50	20	8,25	.325	1,5	.058	3685 000 0078	3688 000 0078	3638 000 0078

CAMPERA 160, F160, F165, F170A, F180A, F5, F55A, F6, F7, F8	40	16	9,32	3/8	1,5	.058	3651 000 0060		3622 000 0060
	45	18	9,32	3/8	1,5	.058	3651 000 0068		3622 000 0068
	50	20	9,32	3/8	1,5	.058	3651 000 0072		3622 000 0072
	58	23	9,32	3/8	1,5	.058	3651 000 0080		3622 000 0080
	63	25	9,32	3/8	1,5	.058	3651 000 0088		3622 000 0088

	40	16	10,26	.404	1,5	.058			3924 000 0055
	45	18	10,26	.404	1,5	.058			3924 000 0062
	50	20	10,26	.404	1,5	.058			3924 000 0066
	58	23	10,26	.404	1,5	.058			3924 000 0073

RS3

STIHL RAPID
Super 3

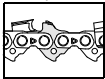

RSK

STIHL RAPID
Super K



RD3

STIHL RAPID
Duro 3

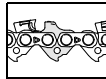

PM

STIHL PICCO
Micro



PD3

STIHL PICCO
Duro 3

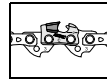

PM3

STIHL PICCO
Micro 3

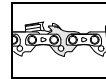

PMM3

STIHL PICCO
Micro Mini 3

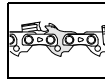

3613 000 0041	3612 000 0041	3636 000 0041
3613 000 0047	3612 000 0047	3636 000 0047
3613 000 0054	3612 000 0054	3636 000 0054
3613 000 0058	3612 000 0058	3636 000 0058

3613 000 0045	3612 000 0045	3636 000 0045
3613 000 0052	3612 000 0052	3636 000 0052
3613 000 0056	3612 000 0056	3636 000 0056

3613 000 0045	3612 000 0045	3636 000 0045
3613 000 0052	3612 000 0052	3636 000 0052
3613 000 0057	3612 000 0057	3636 000 0057

3613 000 0045	3612 000 0045	3636 000 0045
3613 000 0052	3612 000 0052	3636 000 0052
3613 000 0057	3612 000 0057	3636 000 0057

3624 000 0054 3874 000 0054 3681 000 0054

3613 000 0044	3612 000 0044	3636 000 0044
3613 000 0049	3612 000 0049	3636 000 0049
3613 000 0055	3612 000 0055	3636 000 0055

3893 000 0060
3893 000 0068
3893 000 0072
3893 000 0080
3893 000 0088

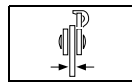
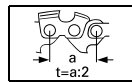
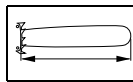

RM STIHL RAPID Micro



RM3 STIHL RAPID Micro 3

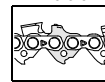

RS STIHL RAPID Super



FRONTIER

F35AV, FB35,	30	12	9,32	3/8 P	1,3	.050			
FB35AV, FB35VIP,	35	14	9,32	3/8 P	1,3	.050			
FP35, FP365VIP,	40	16	9,32	3/8 P	1,3	.050			
MK1									
FP45	40	16	8,25	.325	1,3	.050	3684 000 0065	3687 000 0065	3637 000 0065
	43	17	8,25	.325	1,3	.050	3684 000 0072	3687 000 0072	3637 000 0072
	45	18	8,25	.325	1,3	.050	3684 000 0072	3687 000 0072	3637 000 0072

HANDY

30HF, 35HF, 41HF,	30	12	9,32	3/8 P	1,3	.050			
E140F	35	14	9,32	3/8 P	1,3	.050			
	40	16	9,32	3/8 P	1,3	.050			
40HF	28	11	8,25	.325	1,5	.058	3685 000 0052	3688 000 0052	3638 000 0052
	33	13	8,25	.325	1,5	.058	3685 000 0056	3688 000 0056	3638 000 0056
	35	14	8,25	.325	1,5	.058	3685 000 0060	3688 000 0060	3638 000 0060
	38	15	8,25	.325	1,5	.058	3685 000 0064	3688 000 0064	3638 000 0064
	40	16	8,25	.325	1,5	.058	3685 000 0066	3688 000 0066	3638 000 0066
	43	17	8,25	.325	1,5	.058	3685 000 0068	3688 000 0068	3638 000 0068
	45	18	8,25	.325	1,5	.058	3685 000 0072	3688 000 0072	3638 000 0072
	50	20	8,25	.325	1,5	.058	3685 000 0078	3688 000 0078	3638 000 0078

HITACHI

CS280A, CS280B,	30	12	9,32	3/8 P	1,3	.050			
CS350A, CS350B	35	14	9,32	3/8 P	1,3	.050			
	40	16	9,32	3/8 P	1,3	.050			

HOMELITE

192, 200, 205, 240,	20	8	9,32	3/8 P	1,3	.050			
245, SL, SUPER 2SL,	25	10	9,32	3/8 P	1,3	.050			
VI SUPER 2SL,	30	12	9,32	3/8 P	1,3	.050			
XEL ELECTRIC, XL,	30	12	9,32	3/8 P	1,3	.050			
XL2, XL2 SUPER,	35	14	9,32	3/8 P	1,3	.050			
XLTI, BANDIT LX30,	35	14	9,32	3/8 P	1,3	.050			
SABRE31, 33, 3350 B	40	16	9,32	3/8 P	1,3	.050			
250, 290, 290C,	33	13	8,25	.325	1,3	.050	3684 000 0057	3687 000 0057	3637 000 0057
300, 340, 340C, 4550B	35	14	8,25	.325	1,3	.050	3684 000 0061	3687 000 0061	3637 000 0061
	38	15	8,25	.325	1,3	.050	3684 000 0065	3687 000 0065	3637 000 0065
	40	16	8,25	.325	1,3	.050	3684 000 0069	3687 000 0069	3637 000 0069
	45	18	8,25	.325	1,3	.050	3684 000 0073	3687 000 0073	3637 000 0073
150, EZ, EZ AUTO,	30	12	8,25	.325	1,3	.050	3684 000 0054	3687 000 0054	3637 000 0054
SUPER EZ AUTO,	33	13	8,25	.325	1,3	.050	3684 000 0056	3687 000 0056	3637 000 0056
MINI, SUPER XL MINI,	35	14	8,25	.325	1,3	.050	3684 000 0061	3687 000 0061	3637 000 0061
VI SUPER MINI,	40	16	8,25	.325	1,3	.050	3684 000 0067	3687 000 0067	3637 000 0067
VI-123, VI-125, XL,	45	18	8,25	.325	1,3	.050	3684 000 0072	3687 000 0072	3637 000 0072
XL100 SERIES,	50	20	8,25	.325	1,3	.050	3684 000 0078	3687 000 0078	3637 000 0078
XL250	30	12	9,32	3/8	1,3	.050	3650 000 0049		3623 000 0049
	35	14	9,32	3/8	1,3	.050	3650 000 0054		3623 000 0054
	40	16	9,32	3/8	1,3	.050	3650 000 0059		3623 000 0059
	50	20	9,32	3/8	1,3	.050	3650 000 0070		3623 000 0070
	60	24	9,32	3/8	1,3	.050	3650 000 0081		3623 000 0081
250, 290, 290C,	33	13	8,25	.325	1,5	.058	3685 000 0057	3688 000 0057	3638 000 0057
300, 340, 340C, 4550B	35	14	8,25	.325	1,5	.058	3685 000 0061	3688 000 0061	3638 000 0061
	38	15	8,25	.325	1,5	.058	3685 000 0065	3688 000 0065	3638 000 0065
	40	16	8,25	.325	1,5	.058	3685 000 0067	3688 000 0067	3638 000 0067
	40	16	8,25	.325	1,5	.058	3685 000 0069	3688 000 0069	3638 000 0069
	45	18	8,25	.325	1,5	.058	3685 000 0073	3688 000 0073	3638 000 0073
	50	20	8,25	.325	1,5	.058	3685 000 0078	3688 000 0078	3638 000 0078

RS3

STIHL RAPID
Super 3

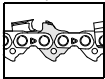

RSK

STIHL RAPID
Super K



RD3

STIHL RAPID
Duro 3

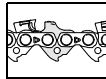

PM

STIHL PICCO
Micro



PD3

STIHL PICCO
Duro 3

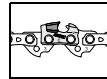

PM3

STIHL PICCO
Micro 3

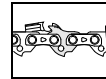

PMM3

STIHL PICCO
Micro Mini 3

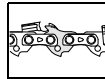

3613 000 0045	3612 000 0045	3636 000 0045
3613 000 0052	3612 000 0052	3636 000 0052
3613 000 0056	3612 000 0056	3636 000 0056

3613 000 0044	3612 000 0044	3636 000 0044
3613 000 0049	3612 000 0049	3636 000 0049
3613 000 0055	3612 000 0055	3636 000 0055

3613 000 0045	3612 000 0045	3636 000 0045
3613 000 0052	3612 000 0052	3636 000 0052
3613 000 0057	3612 000 0057	3636 000 0057

3613 000 0037	3612 000 0037	3636 000 0037
3613 000 0042	3612 000 0042	3636 000 0042
3613 000 0048	3612 000 0048	3636 000 0048
3613 000 0049	3612 000 0049	3636 000 0049
3613 000 0052	3612 000 0052	3636 000 0052
3613 000 0053	3612 000 0053	3636 000 0053
3613 000 0059	3612 000 0059	3636 000 0059

3624 000 0049	3874 000 0049	3681 000 0049
3624 000 0054	3874 000 0054	3681 000 0054
3624 000 0059	3874 000 0059	3681 000 0059
3624 000 0070	3874 000 0070	3681 000 0070
3624 000 0081	3874 000 0081	3681 000 0081

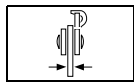
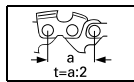
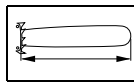

RM STIHL RAPID Micro



RM3 STIHL RAPID Micro 3

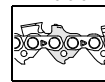

RS STIHL RAPID Super



=> HOMELITE

330, 350, 360AO,	40	16	9,32	3/8	1,3	.050	3650 000 0060		3623 000 0060
360SL, 410, 450,	50	20	9,32	3/8	1,3	.050	3650 000 0070		3623 000 0070
450SL, 550, 550SL,	60	24	9,32	3/8	1,3	.050	3650 000 0081		3623 000 0081
650, 750, 925, 955,	67	27	9,32	3/8	1,3	.050	3650 000 0093		3623 000 0093
SUPER XL AUTO, SXL925, XL12	73	29	9,32	3/8	1,3	.050	3650 000 0098		3623 000 0098

1000XP, 1020, 2100, 700D SERIES, S1050 AUTO	43	17	9,32	3/8	1,6	.063	3652 000 0068	3664 000 0068	3621 000 0068
	53	21	9,32	3/8	1,6	.063	3652 000 0078	3664 000 0078	3621 000 0078
	63	25	9,32	3/8	1,6	.063	3652 000 0090	3664 000 0090	3621 000 0090

SUPER 1050XP, WIZ, X SERIES, XP SERIES, XP2000, ZIP, 360	43	17	10,26	.404	1,6	.063	3668 000 0062		3946 000 0062
	53	21	10,26	.404	1,6	.063	3668 000 0071		3946 000 0071
	63	25	10,26	.404	1,6	.063	3668 000 0082		3946 000 0082

HUSQVARNA

33, 36, 41, HUSKY34,	30	12	9,32	3/8 P	1,3	.050			
HUSKY35, HUSKY37,	35	14	9,32	3/8 P	1,3	.050			
136, 315 E, 316 E, 141, 40	16	16	9,32	3/8 P	1,3	.050			
318 E, 333, 334, 335XP, 338									

HUSKY32, HUSKY38	30	12	9,32	3/8 P	1,3	.050			
	35	14	9,32	3/8 P	1,3	.050			
	40	16	9,32	3/8 P	1,3	.050			

235, 240, T339XP, 543XP, 545, 550XP	33	13	8,25	.325	1,3	.050	3684 000 0056	3687 000 0056	3637 000 0056
	38	15	8,25	.325	1,3	.050	3684 000 0064	3687 000 0064	3637 000 0064
	40	16	8,25	.325	1,3	.050	3684 000 0066	3687 000 0066	3637 000 0066
	45	18	8,25	.325	1,3	.050	3684 000 0072	3687 000 0072	3637 000 0072

543XP	33	13	8,25	.325	1,5	.058	3685 000 0056	3688 000 0056	3638 000 0056
	38	15	8,25	.325	1,5	.058	3685 000 0064	3688 000 0064	3638 000 0064
	40	16	8,25	.325	1,5	.058	3685 000 0066	3688 000 0066	3638 000 0066
	45	18	8,25	.325	1,5	.058	3685 000 0072	3688 000 0072	3638 000 0072

545, 550XP	51	20	8,25	.325	1,5	.058	3685 000 0080	3688 000 0080	3638 000 0080
------------	----	----	------	------	-----	------	---------------	---------------	---------------

133, 136, 141, 154, 234, 28	11	8,25	.325	1,5	.058	3685 000 0052	3688 000 0052	3638 000 0052
238, 242, 242XP, 246, 33	13	8,25	.325	1,5	.058	3685 000 0056	3688 000 0056	3638 000 0056
254, 254XP, 257, 262, 35	14	8,25	.325	1,5	.058	3685 000 0060	3688 000 0060	3638 000 0060
262XP, 33, 36, 340, 345, 38	15	8,25	.325	1,5	.058	3685 000 0064	3688 000 0064	3638 000 0064
346, 350, 351, 353, 355, 40	16	8,25	.325	1,5	.058	3685 000 0066	3688 000 0066	3638 000 0066
357, 359, 362XP, 375XP43	17	8,25	.325	1,5	.058	3685 000 0068	3688 000 0068	3638 000 0068
40, 40P, 41, 42, 44, 45	18	8,25	.325	1,5	.058	3685 000 0072	3688 000 0072	3638 000 0072
435, 440, 444, 445, 45, 50	20	8,25	.325	1,5	.058	3685 000 0078	3688 000 0078	3638 000 0078
450, 455, 460, 50, 51, 55, 555, 560XP, 560XPG E 16, E 1200, E 1600, EL1400, EL1500								

136 Li	30	12	9,32	3/8 P	1,1	.043			
--------	----	----	------	-------	-----	------	--	--	--

T540XP	30	12	9,32	3/8	1,3	.050	3650 000 0045		3623 000 0045
	35	14	9,32	3/8	1,3	.050	3650 000 0052		3623 000 0052
	40	16	9,32	3/8	1,3	.050	3650 000 0056		3623 000 0056

562XP	38	15	9,32	3/8	1,5	.058	3651 000 0056		3622 000 0056
	40	16	9,32	3/8	1,5	.058	3651 000 0060		3622 000 0060
	45	18	9,32	3/8	1,5	.058	3651 000 0068		3622 000 0068
	51	20	9,32	3/8	1,5	.058	3651 000 0072		3622 000 0072
	61	24	9,32	3/8	1,5	.058	3651 000 0084		3622 000 0084
	71	28	9,32	3/8	1,5	.058	3651 000 0092		3622 000 0092

RS3

STIHL RAPID
Super 3



RSK

STIHL RAPID
Super K



RD3

STIHL RAPID
Duro 3

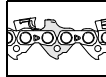

PM

STIHL PICCO
Micro



PD3

STIHL PICCO
Duro 3



PM3

STIHL PICCO
Micro 3

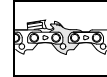

PMM3

STIHL PICCO
Micro Mini 3

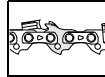

3624 000 0060	3874 000 0060	3681 000 0060
3624 000 0070	3874 000 0070	3681 000 0070
3624 000 0081	3874 000 0081	3681 000 0081
3624 000 0093	3874 000 0093	3681 000 0093
3624 000 0098	3874 000 0098	3681 000 0098

3626 000 0068	3898 000 0068	3683 000 0068
3626 000 0078	3898 000 0078	3683 000 0078
3626 000 0090	3898 000 0090	3683 000 0090

3846 000 0062
3846 000 0071
3846 000 0082

3613 000 0045	3612 000 0045	3636 000 0045
3613 000 0052	3612 000 0052	3636 000 0052
3613 000 0056	3612 000 0056	3636 000 0056

3613 000 0047	3612 000 0047	3636 000 0047
3613 000 0053	3612 000 0053	3636 000 0053
3613 000 0058	3612 000 0058	3636 000 0058

3610 000 0045

3874 000 0045
3874 000 0052
3874 000 0056

3893 000 0056
3893 000 0060
3893 000 0068
3893 000 0072
3893 000 0084
3893 000 0092

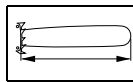

cm in.

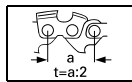

mm in.

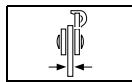

mm in.

RM

STIHL RAPID
Micro



RM3

STIHL RAPID
Micro 3

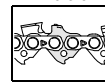

RS

STIHL RAPID
Super



=> HUSQVARNA

33, 36, 40, 40P, 41, 44,	33	13	9,32	3/8	1,5	.058	3651 000 0050		3622 000 0050
45, 50, 51, 55, 61, 65,	33	13	9,32	3/8	1,5	.058	3651 000 0052		3622 000 0052
66, 77, 133, 154, 162,	38	15	9,32	3/8	1,5	.058	3651 000 0056		3622 000 0056
181, 234, 238, 242,	40	16	9,32	3/8	1,5	.058	3651 000 0060		3622 000 0060
242XP, 254, 254XP,	43	17	9,32	3/8	1,5	.058	3651 000 0064		3622 000 0064
257, 262, 262XP, 266,	45	18	9,32	3/8	1,5	.058	3651 000 0068		3622 000 0068
266XP, 268XP, 272,	50	20	9,32	3/8	1,5	.058	3651 000 0072		3622 000 0072
272XP, 281, 281XP,	55	22	9,32	3/8	1,5	.058	3651 000 0076		3622 000 0076
285, 288XP, 298XP,	55	22	9,32	3/8	1,5	.058	3651 000 0077		3622 000 0077
340, 355, 357, 359,	60	24	9,32	3/8	1,5	.058	3651 000 0084		3622 000 0084
362, 365, 371, 372XP,	65	26	9,32	3/8	1,5	.058	3651 000 0089		3622 000 0089
380, 385 XP, 394XP,	70	28	9,32	3/8	1,5	.058	3651 000 0092		3622 000 0092
395XP, 455, 460, 480,									
555, 560XP, 560XPG,	55	22	10,26	.404	1,6	.063	3668 000 0068		3946 000 0068
570, 575XP, 576XP,	60	24	10,26	.404	1,6	.063	3668 000 0076		3946 000 0076
EL1400, EL1500, 2100,	90	36	10,26	.404	1,6	.063	3668 000 0104		3946 000 0104
2100XP, 3120XP									

3120XP, 395

HYDRASAW

MILES ROYSTOW	45	18	9,32	3/8	1,5	.058	3651 000 0070		3622 000 0070
	55	22	9,32	3/8	1,5	.058	3651 000 0079		3622 000 0079

IKRA

A104P, A104S, A204S,	30	12	9,32	3/8 P	1,3	.050			
A205B, FA12, H014A,	35	14	9,32	3/8 P	1,3	.050			
KS12, KS14, KS14A,	40	16	9,32	3/8 P	1,3	.050			
KS1400A, KS400,									
SHARK,									
SUPER PRO 1500									

JCB HYDROCHIEF

JCB HYDROCHIEF	43	17	9,32	3/8	1,6	.063	3652 000 0067	3664 000 0067	3621 000 0067
All models	53	21	9,32	3/8	1,6	.063	3652 000 0075	3664 000 0075	3621 000 0075
	63	25	9,32	3/8	1,6	.063	3652 000 0083	3664 000 0083	3621 000 0083
	43	17	10,26	.404	1,6	.063	3668 000 0060		3946 000 0060
	53	21	10,26	.404	1,6	.063	3668 000 0068		3946 000 0068
	63	25	10,26	.404	1,6	.063	3668 000 0080		3946 000 0080

JOBU

SL-3, SL31, SL35,	30	12	9,32	3/8 P	1,3	.050			
SL41, SL361,	35	14	9,32	3/8 P	1,3	.050			
941, 941S,	40	16	9,32	3/8 P	1,3	.050			
EL 880, EL 1201									
LP4, LP40,	28	11	8,25	.325	1,5	.058	3685 000 0052	3688 000 0052	3638 000 0052
LP5, LP50, LP6,	33	13	8,25	.325	1,5	.058	3685 000 0056	3688 000 0056	3638 000 0056
949, 949S, EL14	35	14	8,25	.325	1,5	.058	3685 000 0060	3688 000 0060	3638 000 0060
	38	15	8,25	.325	1,5	.058	3685 000 0064	3688 000 0064	3638 000 0064
	40	16	8,25	.325	1,5	.058	3685 000 0068	3688 000 0068	3638 000 0068
	43	17	8,25	.325	1,5	.058	3685 000 0068	3688 000 0068	3638 000 0068
	45	18	8,25	.325	1,5	.058	3685 000 0072	3688 000 0072	3638 000 0072
	50	20	8,25	.325	1,5	.058	3685 000 0078	3688 000 0078	3638 000 0078
	33	13	9,32	3/8	1,5	.058	3651 000 0050		3622 000 0050
	38	15	9,32	3/8	1,5	.058	3651 000 0056		3622 000 0056
	40	16	9,32	3/8	1,5	.058	3651 000 0059		3622 000 0059

RS3

STIHL RAPID
Super 3



RSK

STIHL RAPID
Super K



RD3

STIHL RAPID
Duro 3

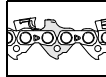

PM

STIHL PICCO
Micro



PD3

STIHL PICCO
Duro 3

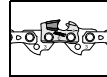

PM3

STIHL PICCO
Micro 3

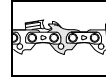

PMM3

STIHL PICCO
Micro Mini 3

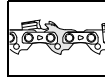

3893 000 0050
3893 000 0052
3893 000 0056
3893 000 0060
3893 000 0064
3893 000 0068
3893 000 0072
3893 000 0076
3893 000 0077
3893 000 0084
3893 000 0089
3893 000 0092

3846 000 0068
3846 000 0076
3846 000 0104

3893 000 0070
3893 000 0079

3613 000 0045	3612 000 0045	3636 000 0045
3613 000 0052	3612 000 0052	3636 000 0052
3613 000 0057	3612 000 0057	3636 000 0057

3626 000 0067	3898 000 0067	3683 000 0067
3626 000 0075	3898 000 0075	3683 000 0075
3626 000 0083	3898 000 0083	3683 000 0083

3846 000 0060
3846 000 0068
3846 000 0080

3613 000 0045	3612 000 0045	3636 000 0045
3613 000 0052	3612 000 0052	3636 000 0052
3613 000 0057	3612 000 0057	3636 000 0057

3893 000 0050
3893 000 0056
3893 000 0059

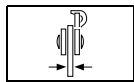
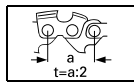
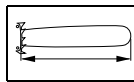

RM
STIHL RAPID
Micro



RM3
STIHL RAPID
Micro 3

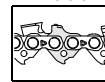

RS
STIHL RAPID
Super



	cm	in.	mm	in.	mm	in.			
JONSERED BABY SAW, M 36, M 361, 36 AV, 365, 370, 380	30	12	6,35	1/4	1,3	.050	3660 000 0064		
	30	12	9,32	3/8 P	1,3	.050			
	35	14	9,32	3/8 P	1,3	.050			
	40	16	9,32	3/8 P	1,3	.050			
2036, 2040	35	14	9,32	3/8 P	1,3	.050			
	40	16	9,32	3/8 P	1,3	.050			
370, 380, 410, 420, 435, 450, 451E, 451EV, 451EVS, 452, 455, 45E, 49SP, 490, 50, 51, 52, 510, 520, 525, 535, 590, 2012, 2014, 2015, 2016, 2036, 2041, 2045, 2046, 2050, 2051, 2054, EL14, 2136, CS2250, CS2245, CS2141, CS2145, CS2150, CS2255, CS2152	28	11	8,25	.325	1,5	.058	3685 000 0052	3688 000 0052	3638 000 0052
	33	13	8,25	.325	1,5	.058	3685 000 0056	3688 000 0056	3638 000 0056
	35	14	8,25	.325	1,5	.058	3685 000 0060	3688 000 0060	3638 000 0060
	38	15	8,25	.325	1,5	.058	3685 000 0064	3688 000 0064	3638 000 0064
	40	16	8,25	.325	1,5	.058	3685 000 0066	3688 000 0066	3638 000 0066
	43	17	8,25	.325	1,5	.058	3685 000 0068	3688 000 0068	3638 000 0068
	45	18	8,25	.325	1,5	.058	3685 000 0072	3688 000 0072	3638 000 0072
	50	20	8,25	.325	1,5	.058	3685 000 0078	3688 000 0078	3638 000 0078
60, 62, 66, 70, 75, 80, 90, 601, 621, 625, 630, 630 SUPER, 670, 670 SUPER, 670 CHAMP, 801, 820, 830, 910E, 920, 930, 1020, 2063, 2065, 2071, 2077, 2083, 2094, 2095, 2165, CS2171, CS2186	33	13	9,32	3/8	1,5	.058	3651 000 0052		3622 000 0052
	38	15	9,32	3/8	1,5	.058	3651 000 0056		3622 000 0056
	40	16	9,32	3/8	1,5	.058	3651 000 0058		3622 000 0058
	40	16	9,32	3/8	1,5	.058	3651 000 0060		3622 000 0060
	43	17	9,32	3/8	1,5	.058	3651 000 0064		3622 000 0064
	45	18	9,32	3/8	1,5	.058	3651 000 0068		3622 000 0068
	50	20	9,32	3/8	1,5	.058	3651 000 0072		3622 000 0072
	55	22	9,32	3/8	1,5	.058	3651 000 0076		3622 000 0076
	58	23	9,32	3/8	1,5	.058	3651 000 0080		3622 000 0080
	60	24	9,32	3/8	1,5	.058	3651 000 0084		3622 000 0084
	63	25	9,32	3/8	1,5	.058	3651 000 0088		3622 000 0088
	75	30	9,32	3/8	1,5	.058	3651 000 0098		3622 000 0098
625, 630, 630 SUPER, 670, 670 SUPER, 2077, 2094, 2095	53	21	10,26	.404	1,5	.058			3924 000 0068
	55	22	10,26	.404	1,6	.063	3668 000 0068		3946 000 0068
	60	24	10,26	.404	1,6	.063	3668 000 0076		3946 000 0076
KRESS DUO, ELEKTRONIK DUO	25	10	9,32	3/8 P	1,3	.050			
LANDONI 771, 772	35	14	8,25	.325	1,3	.050	3684 000 0060	3687 000 0060	3637 000 0060
	40	16	8,25	.325	1,3	.050	3684 000 0064	3687 000 0064	3637 000 0064
	45	18	8,25	.325	1,3	.050	3684 000 0070	3687 000 0070	3637 000 0070
773, L20	40	16	9,32	3/8	1,3	.050	3650 000 0058		3623 000 0058
	50	20	9,32	3/8	1,3	.050	3650 000 0070		3623 000 0070
	60	24	9,32	3/8	1,3	.050	3650 000 0080		3623 000 0080
LEROY SOMER TLS1412, TLS1530, TLS1614, TLS1616, TLS1635, TLS1716	30	12	9,32	3/8 P	1,3	.050			
	35	14	9,32	3/8 P	1,3	.050			
	40	16	9,32	3/8 P	1,3	.050			
LOMBARD AP-22, AP-24 LITTLE LIGHTNING, PONY	30	12	9,32	3/8 P	1,3	.050			
	30	12	9,32	3/8 P	1,3	.050			
	35	14	9,32	3/8 P	1,3	.050			
	40	16	9,32	3/8 P	1,3	.050			

RS3

STIHL RAPID
Super 3

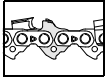

RSK

STIHL RAPID
Super K



RD3

STIHL RAPID
Duro 3

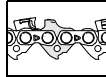

PM

STIHL PICCO
Micro



PD3

STIHL PICCO
Duro 3



PM3

STIHL PICCO
Micro 3

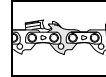

PMM3

STIHL PICCO
Micro Mini 3

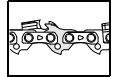

3613 000 0045	3612 000 0045	3636 000 0045
3613 000 0052	3612 000 0052	3636 000 0052
3613 000 0057	3612 000 0057	3636 000 0057

3613 000 0052	3612 000 0052	3636 000 0052
3613 000 0056	3612 000 0056	3636 000 0056

3893 000 0052
3893 000 0056
3893 000 0058
3893 000 0060
3893 000 0064
3893 000 0068
3893 000 0072
3893 000 0076
3893 000 0080
3893 000 0084
3893 000 0088
3893 000 0098

3846 000 0068
3846 000 0076

3613 000 0036	3612 000 0036	3636 000 0036
---------------	---------------	---------------

3624 000 0058	3874 000 0058	3681 000 0058
3624 000 0070	3874 000 0070	3681 000 0070
3624 000 0080	3874 000 0080	3681 000 0080

3613 000 0045	3612 000 0045	3636 000 0045
3613 000 0050	3612 000 0050	3636 000 0050
3613 000 0056	3612 000 0056	3636 000 0056

3613 000 0044	3612 000 0044	3636 000 0044
3613 000 0045	3612 000 0045	3636 000 0045
3613 000 0052	3612 000 0052	3636 000 0052
3613 000 0055	3612 000 0055	3636 000 0055

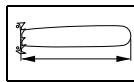

cm in.

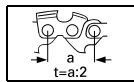

mm in.

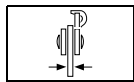

mm in.

RM

STIHL RAPID
Micro



RM3

STIHL RAPID
Micro 3

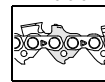

RS

STIHL RAPID
Super



=> LOMBARD

ALL-SERIES,	40	16	9,32	3/8	1,3	.050	3650 000 0060		3623 000 0060
LIGHTNING SERIES,	45	18	9,32	3/8	1,3	.050	3650 000 0066		3623 000 0066
GLP-SERIES,	50	20	9,32	3/8	1,3	.050	3650 000 0070		3623 000 0070
COMANGO	60	24	9,32	3/8	1,3	.050	3650 000 0081		3623 000 0081

MAFELL

BS300, EKS400	40	16	9,32	3/8 P	1,3	.050			
KSU330	35	14	8,25	.325	1,3	.050	3684 000 0061	3687 000 0061	3637 000 0061
ZS200E, ZS330	35	14	9,32	3/8	1,3	.050	3650 000 0054		3623 000 0054

MAKITA

DCS330S, DCS390,	30	12	9,32	3/8 P	1,3	.050			
DCS400, DCS401,	35	14	9,32	3/8 P	1,3	.050			
DCS350, DCS380,	40	16	9,32	3/8 P	1,3	.050			
5011B, 5012B, 5014B,									
5014NB, 5016B,									
5016NB									
DCS420, DCS430,	28	11	8,25	.325	1,5	.058	3685 000 0052	3688 000 0052	3638 000 0052
DCS520, DCS4300I,	33	13	8,25	.325	1,5	.058	3685 000 0056	3688 000 0056	3638 000 0056
DCS4301, DCS5200I,	35	14	8,25	.325	1,5	.058	3685 000 0060	3688 000 0060	3638 000 0060
DCS6800I	38	15	8,25	.325	1,5	.058	3685 000 0064	3688 000 0064	3638 000 0064
	43	17	8,25	.325	1,5	.058	3685 000 0068	3688 000 0068	3638 000 0068
	45	18	8,25	.325	1,5	.058	3685 000 0072	3688 000 0072	3638 000 0072
	50	20	8,25	.325	1,5	.058	3685 000 0078	3688 000 0078	3638 000 0078
DCS230, DCS460,	38	15	9,32	3/8	1,5	.058	3651 000 0056		3622 000 0056
DC4610, DCS6001,	43	17	9,32	3/8	1,5	.058	3651 000 0064		3622 000 0064
9000,	45	18	9,32	3/8	1,5	.058	3651 000 0064		3622 000 0064
DCS7300, DCS7900,	50	20	9,32	3/8	1,5	.058	3651 000 0072		3622 000 0072
DCS9010	53	21	9,32	3/8	1,5	.058	3651 000 0072		3622 000 0072
	58	23	9,32	3/8	1,5	.058	3651 000 0080		3622 000 0080

McCULLOCH

M1, M2, M2B, M4,	25	10	9,32	3/8 P	1,3	.050			
M4B, M6, M6B	30	12	9,32	3/8 P	1,3	.050			
	35	14	9,32	3/8 P	1,3	.050			
	40	16	9,32	3/8 P	1,3	.050			
474, 484, 735, C180,	30	12	9,32	3/8 P	1,3	.050			
CALIFORNIA/ARIZON,	35	14	9,32	3/8 P	1,3	.050			
CALIFORNIAN,	35	14	9,32	3/8 P	1,3	.050			
EAGER BEAVER,	40	16	9,32	3/8 P	1,3	.050			
MAC 120, MAC 130,	45	18	9,32	3/8 P	1,3	.050			
POWER MAC 6,									
MM25, MM30, MM35,									
PM6, PM310, PM320,									
PM330, PM340,									
PM360, PM364,									
PM370, PM470,									
PM480, PM510,									
PM730,									
Statesman Senator									
PM394, PM494	30	12	9,32	3/8 P	1,3	.050			
PM394, PM494,	35	14	9,32	3/8 P	1,3	.050			
CS350, CS390	40	16	9,32	3/8 P	1,3	.050			
ELECTRICMAC 16E	40	16	9,32	3/8 P	1,3	.050			

RS3

STIHL RAPID
Super 3



RSK

STIHL RAPID
Super K



RD3

STIHL RAPID
Duro 3

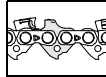

PM

STIHL PICCO
Micro



PD3

STIHL PICCO
Duro 3



PM3

STIHL PICCO
Micro 3

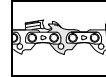

PMM3

STIHL PICCO
Micro Mini 3

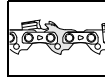

3624 000 0060 3874 000 0060 3681 0000 0060
 3624 000 0066 3874 000 0066 3681 0000 0066
 3624 000 0070 3874 000 0070 3681 0000 0070
 3624 000 0081 3874 000 0081 3681 0000 0081

3613 000 0057 3612 000 0057 3636 000 0057

3624 000 0054 3874 000 0054 3681 000 0054

3613 00 0045 3612 000 0045 3636 000 0045
 3613 00 0052 3612 000 0052 3636 000 0052
 3613 00 0057 3612 000 0057 3636 000 0057

3893 000 0056
 3893 000 0064
 3893 000 0064
 3893 000 0072
 3893 000 0072
 3893 000 0080

3613 000 0038 3612 000 0038 3636 000 0038
 3613 000 0044 3612 000 0044 3636 000 0044
 3613 000 0050 3612 000 0050 3636 000 0050
 3613 000 0056 3612 000 0056 3636 000 0056

3613 000 0044 3612 000 0044 3636 000 0044
 3613 000 0049 3612 000 0049 3636 000 0049
 3613 000 0050 3612 000 0050 3636 000 0050
 3613 000 0055 3612 000 0055 3636 000 0055
 3613 000 0060 3612 000 0060 3636 000 0060

3613 000 0044 3612 000 0044 3636 000 0044

3613 000 0052 3612 000 0052 3636 000 0052
 3613 000 0056 3612 000 0056 3636 000 0056

3613 000 0054 3612 000 0054 3636 000 0054

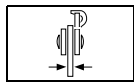
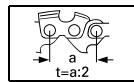
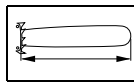

RM STIHL RAPID Micro



RM3 STIHL RAPID Micro 3

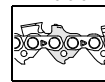

RS STIHL RAPID Super



=> McCULLOCH

3500, 400P, TITAN 35, TITAN 40	35	14	8,25	.325	1,3	.050	3684 000 0056	3687 000 0056	3637 000 0056
	40	16	8,25	.325	1,3	.050	3684 000 0064	3687 000 0064	3637 000 0064
CS410, CS450	33	13	8,25	.325	1,3	.050	3684 000 0056	3687 000 0056	3637 000 0056
	38	15	8,25	.325	1,3	.050	3684 000 0064	3687 000 0064	3637 000 0064
	40	16	8,25	.325	1,3	.050	3684 000 0066	3687 000 0066	3637 000 0066
	45	18	8,25	.325	1,3	.050	3684 000 0072	3687 000 0072	3637 000 0072
1-10, 2-10, 3-10, 4-10, 5-10, 6-10, 7-10, 10-10, 55, 60, 70, 80, 555, 650, 655, 700, 800, 805, 850, DE50, SP60, SP81, TITAN 50, TITAN 57, 1000, CP55, CP70, CP70L	30	12	9,32	3/8	1,3	.050	3650 000 0050		3623 000 0050
	40	16	9,32	3/8	1,3	.050	3650 000 0060		3623 000 0060
	50	20	9,32	3/8	1,3	.050	3650 000 0071		3623 000 0071
	60	24	9,32	3/8	1,3	.050	3650 000 0081		3623 000 0081
	70	28	9,32	3/8	1,3	.050	3650 000 0092		3623 000 0092
TITAN 57, 1000, CP55, CP70, CP70L	40	16	9,32	3/8	1,5	.058	3651 000 0060		3622 000 0060
	50	20	9,32	3/8	1,5	.058	3651 000 0071		3622 000 0071
	60	24	9,32	3/8	1,5	.058	3651 000 0081		3622 000 0081

METABO

5338	30	12	6,35	1/4	1,3	.050	3660 000 0064		
	35	14	6,35	1/4	1,3	.050	3660 000 0072		
KT 1530, S 338	30	12	9,32	3/8 P	1,3	.050			
	35	14	9,32	3/8 P	1,3	.050			
	40	16	9,32	3/8 P	1,3	.050			
KT 1440	40	16	9,32	3/8 P	1,3	.050			

MONDIAL

V5, V6, V6 SUPER	28	11	8,25	.325	1,5	.058	3685 000 0052	3688 000 0052	3638 000 0052
	33	13	8,25	.325	1,5	.058	3685 000 0056	3688 000 0056	3638 000 0056
	35	14	8,25	.325	1,5	.058	3685 000 0060	3688 000 0060	3638 000 0060
	38	15	8,25	.325	1,5	.058	3685 000 0064	3688 000 0064	3638 000 0064
	40	16	8,25	.325	1,5	.058	3685 000 0066	3688 000 0066	3638 000 0066
	43	17	8,25	.325	1,5	.058	3685 000 0068	3688 000 0068	3638 000 0068
	45	18	8,25	.325	1,5	.058	3685 000 0072	3688 000 0072	3638 000 0072
	50	20	8,25	.325	1,5	.058	3685 000 0078	3688 000 0078	3638 000 0078

NAUTAC

135, 140, 144, 232, 236	30	12	9,32	3/8 P	1,3	.050			
	35	14	9,32	3/8 P	1,3	.050			
	40	16	9,32	3/8 P	1,3	.050			
244, 246, 252	28	11	8,25	.325	1,5	.058	3685 000 0052	3688 000 0052	3638 000 0052
	33	13	8,25	.325	1,5	.058	3685 000 0056	3688 000 0056	3638 000 0056
	35	14	8,25	.325	1,5	.058	3685 000 0060	3688 000 0060	3638 000 0060
	38	15	8,25	.325	1,5	.058	3685 000 0064	3688 000 0064	3638 000 0064
	40	16	8,25	.325	1,5	.058	3685 000 0066	3688 000 0066	3638 000 0066
	43	17	8,25	.325	1,5	.058	3685 000 0068	3688 000 0068	3638 000 0068
	45	18	8,25	.325	1,5	.058	3685 000 0072	3688 000 0072	3638 000 0072
	50	20	8,25	.325	1,5	.058	3685 000 0078	3688 000 0078	3638 000 0078
149, 155, 170, 256, 256 I	40	16	9,32	3/8	1,5	.058	3651 000 0060		3622 000 0060
	45	18	9,32	3/8	1,5	.058	3651 000 0068		3622 000 0068
	50	20	9,32	3/8	1,5	.058	3651 000 0072		3622 000 0072
	58	23	9,32	3/8	1,5	.058	3651 000 0080		3622 000 0080
	63	25	9,32	3/8	1,5	.058	3651 000 0088		3622 000 0088
	75	30	9,32	3/8	1,5	.058	3651 000 0098		3622 000 0098
149, 155, 170, 256, 256I	40	16	10,26	.404	1,5	.058			3924 000 0055
	45	18	10,26	.404	1,5	.058			3924 000 0062
	50	20	10,26	.404	1,5	.058			3924 000 0066
	58	23	10,26	.404	1,5	.058			3924 000 0073

RS3

STIHL RAPID
Super 3

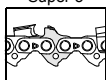

RSK

STIHL RAPID
Super K



RD3

STIHL RAPID
Duro 3

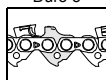

PM

STIHL PICCO
Micro



PD3

STIHL PICCO
Duro 3

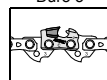

PM3

STIHL PICCO
Micro 3

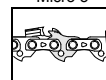

PMM3

STIHL PICCO
Micro Mini 3

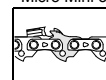

3624 000 0050	3874 000 0050	3681 000 0050
3624 000 0060	3874 000 0060	3681 000 0060
3624 000 0071	3874 000 0071	3681 000 0071
3624 000 0081	3874 000 0081	3681 000 0081
3624 000 0092	3874 000 0092	3681 000 0092

3893 000 0060
3893 000 0071
3893 000 0081

3613 000 0044	3612 000 0044	3636 000 0044
3613 000 0050	3612 000 0050	3636 000 0050
3613 000 0055	3612 000 0055	3636 000 0055

3613 000 0059	3612 000 0059	3636 000 0059
---------------	---------------	---------------

3613 000 0044	3612 000 0044	3636 000 0044
3613 000 0049	3612 000 0049	3636 000 0049
3613 000 0055	3612 000 0055	3636 000 0055

3893 000 0060
3893 000 0068
3893 000 0072
3893 000 0080
3893 000 0088
3893 000 0098

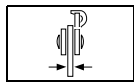
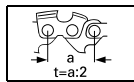
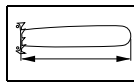

cm

in.

mm

in.

mm

in.

RM

STIHL RAPID
Micro



RM3

STIHL RAPID
Micro 3

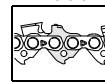

RS

STIHL RAPID
Super



OLEO-MAC - Efco

233, 234, 240, 244,	30	12	9,32	3/8 P	1,3	.050			
335, 340, 930, 935D,	35	14	9,32	3/8 P	1,3	.050			
936, E140F, E170F, OM-E200, GS370, MT3700, GS410C, MT4100	40	16	9,32	3/8 P	1,3	.050			
240, E170, E170F	30	12	8,25	.325	1,3	.050	3684 000 0051	3687 000 0051	3637 000 0051
	35	14	8,25	.325	1,3	.050	3684 000 0057	3687 000 0057	3637 000 0057
	40	16	8,25	.325	1,3	.050	3684 000 0064	3687 000 0064	3637 000 0064
938, 940, 941, 942, 945A, 946, 950 SUPER, 950A, 950, 951, 952, 956, 962, E300F, GS410CX, MT4100SP	28	11	8,25	.325	1,5	.058	3685 000 0052	3688 000 0052	3638 000 0052
	33	13	8,25	.325	1,5	.058	3685 000 0056	3688 000 0056	3638 000 0056
	35	14	8,25	.325	1,5	.058	3685 000 0060	3688 000 0060	3638 000 0060
	38	15	8,25	.325	1,5	.058	3685 000 0064	3688 000 0064	3638 000 0064
	40	16	8,25	.325	1,5	.058	3685 000 0066	3688 000 0066	3638 000 0066
	43	17	8,25	.325	1,5	.058	3685 000 0068	3688 000 0068	3638 000 0068
	45	18	8,25	.325	1,5	.058	3685 000 0072	3688 000 0072	3638 000 0072
	50	20	8,25	.325	1,5	.058	3685 000 0078	3688 000 0078	3638 000 0078
250 A, 251, 251B, 251 Super, 252, 254, 261, 264, 271, 272, 284, 350, 350 SUPER, 355, 460, 480, 481, 482, 484, E300, OM-E300, 970, 971, 980, 981, GS720, MT7200, GS820, MT8200,	40	16	9,32	3/8	1,5	.058	3651 000 0060		3622 000 0060
	45	18	9,32	3/8	1,5	.058	3651 000 0068		3622 000 0068
	50	20	9,32	3/8	1,5	.058	3651 000 0072		3622 000 0072
	58	23	9,32	3/8	1,5	.058	3651 000 0080		3622 000 0080
	63	25	9,32	3/8	1,5	.058	3651 000 0088		3622 000 0088
	75	30	9,32	3/8	1,5	.058	3651 000 0098		3622 000 0098
970, 971, 980, 981	40	16	10,26	.404	1,5	.058			3924 000 0055
	45	18	10,26	.404	1,5	.058			3924 000 0062
	50	20	10,26	.404	1,5	.058			3924 000 0066
	58	23	10,26	.404	1,5	.058			3924 000 0073
999, 999F	43	17	10,26	.404	1,6	.063	3668 000 0060		3946 000 0060
	53	21	10,26	.404	1,6	.063	3668 000 0068		3946 000 0068
	63	25	10,26	.404	1,6	.063	3668 000 0080		3946 000 0080
	75	30	10,26	.404	1,6	.063	3668 000 0092		3924 000 0055
OPEM									
130Z, 140Z, 142Z	30	12	9,32	3/8 P	1,3	.050			
	35	14	9,32	3/8 P	1,3	.050			
	40	16	9,32	3/8 P	1,3	.050			
K1, K2, K3, K2 SUPER	28	11	8,25	.325	1,5	.058	3685 000 0052	3688 000 0052	3638 000 0052
	33	13	8,25	.325	1,5	.058	3685 000 0056	3688 000 0056	3638 000 0056
	35	14	8,25	.325	1,5	.058	3685 000 0060	3688 000 0060	3638 000 0060
	38	15	8,25	.325	1,5	.058	3685 000 0064	3688 000 0064	3638 000 0064
	40	16	8,25	.325	1,5	.058	3685 000 0066	3688 000 0066	3638 000 0066
	43	17	8,25	.325	1,5	.058	3685 000 0068	3688 000 0068	3638 000 0068
	45	18	8,25	.325	1,5	.058	3685 000 0072	3688 000 0072	3638 000 0072
	50	20	8,25	.325	1,5	.058	3685 000 0078	3688 000 0078	3638 000 0078
145, 150, 155, 157, 157 SUPER, 165, 165 SUPER	40	16	9,32	3/8	1,5	.058	3651 000 0060		3622 000 0060
	43	17	9,32	3/8	1,5	.058	3651 000 0064		3622 000 0064
	48	19	9,32	3/8	1,5	.058	3651 000 0068		3622 000 0068
K3, 145, 150, 155, 157, 157 SUPER, 165, 165 SUPER	40	16	9,32	3/8	1,5	.058	3651 000 0059		3622 000 0059
	43	17	9,32	3/8	1,5	.058	3651 000 0064		3622 000 0064
	45	18	9,32	3/8	1,5	.058	3651 000 0064		3622 000 0064
	50	20	9,32	3/8	1,5	.058	3651 000 0068		3622 000 0068

RS3

STIHL RAPID
Super 3

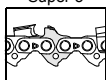

RSK

STIHL RAPID
Super K



RD3

STIHL RAPID
Duro 3

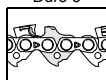

PM

STIHL PICCO
Micro



PD3

STIHL PICCO
Duro 3

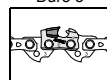

PM3

STIHL PICCO
Micro 3

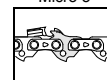

PMM3

STIHL PICCO
Micro Mini 3

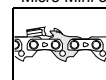

3613 000 0044 3612 000 0044 3636 000 0044
 3613 000 0050 3612 000 0050 3636 000 0050
 3613 000 0056 3612 000 0056 3636 000 0056

3893 000 0060
 3893 000 0068
 3893 000 0072
 3893 000 0080
 3893 000 0088
 3893 000 0098

3846 000 0060
 3846 000 0068
 3846 000 0080
 3846 000 0092

3613 000 0045 3612 000 0045 3636 000 0045
 3613 000 0052 3612 000 0052 3636 000 0052
 3613 000 0057 3612 000 0057 3636 000 0057

3893 000 0060
 3893 000 0064
 3893 000 0068

3893 000 0059
 3893 000 0064
 3893 000 0064
 3893 000 0068

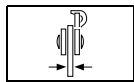
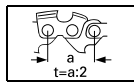
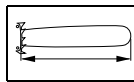

RM STIHL RAPID Micro



RM3 STIHL RAPID Micro 3

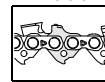

RS STIHL RAPID Super



330, 335, 340, 345, 350,	30	12	9,32	3/8 P	1,3	.050			
351, 360, 365, 370, 385,	35	14	9,32	3/8 P	1,3	.050			
390, 395, 405, 420,	40	16	9,32	3/8 P	1,3	.050			
1601, 1602, 1612, 1613, 1614, 1616, 1618, P538									
P4700, P5300,	35	14	9,32	3/8 P	1,3	.050			
P740, P842	40	16	9,32	3/8 P	1,3	.050			
P4700, P5300	33	13	8,25	.325	1,3	.050	3684 000 0056	3687 000 0056	3637 000 0056
	38	15	8,25	.325	1,3	.050	3684 000 0064	3687 000 0064	3637 000 0064
	45	18	8,25	.325	1,3	.050	3684 000 0072	3687 000 0072	3637 000 0072
360, 365, 400, 405,	28	11	8,25	.325	1,5	.058	3685 000 0052	3688 000 0052	3638 000 0052
450, 465, 495, 540,	33	13	8,25	.325	1,5	.058	3685 000 0056	3688 000 0056	3638 000 0056
545, 550, P461, P462,	35	14	8,25	.325	1,5	.058	3685 000 0060	3688 000 0060	3638 000 0060
P511, P4600, P4900,	38	15	8,25	.325	1,5	.058	3685 000 0064	3688 000 0064	3638 000 0064
P500, P5000, P5200,	40	16	8,25	.325	1,5	.058	3685 000 0066	3688 000 0066	3638 000 0066
P5500, 605, 1400 EL,	43	17	8,25	.325	1,5	.058	3685 000 0068	3688 000 0068	3638 000 0068
MINI FARMER SAW,	45	18	8,25	.325	1,5	.058	3685 000 0072	3688 000 0072	3638 000 0072
1200EL, 1500EL	50	20	8,25	.325	1,5	.058	3685 000 0078	3688 000 0078	3638 000 0078
P500, P5000	33	13	9,32	3/8	1,5	.058	3651 000 0050		3622 000 0050
	38	15	9,32	3/8	1,5	.058	3651 000 0056		3622 000 0056
550, 650, 660, 7000,	33	13	9,32	3/8	1,5	.058	3651 000 0052		3622 000 0052
710, F65, P55, P65, P70	38	15	9,32	3/8	1,5	.058	3651 000 0056		3622 000 0056
P85, P100, P610, P710,	40	16	9,32	3/8	1,5	.058	3651 000 0060		3622 000 0060
R16, R17, R18, R19,	43	17	9,32	3/8	1,5	.058	3651 000 0064		3622 000 0064
R20, R21, R22, R40,	50	20	9,32	3/8	1,5	.058	3651 000 0072		3622 000 0072
R417, R418, R420,	55	22	9,32	3/8	1,5	.058	3651 000 0076		3622 000 0076
R421, R422, R435, R440, R522, R523, S50, S55, S65									
660, P7700,	40	16	9,32	3/8	1,5	.058	3651 000 0060		3622 000 0060
	45	18	9,32	3/8	1,5	.058	3651 000 0068		3622 000 0068
	50	20	9,32	3/8	1,5	.058	3651 000 0072		3622 000 0072
	55	22	9,32	3/8	1,5	.058	3651 000 0077		3622 000 0077
	60	24	9,32	3/8	1,5	.058	3651 000 0084		3622 000 0084
	65	26	9,32	3/8	1,5	.058	3651 000 0089		3622 000 0089
	70	28	9,32	3/8	1,5	.058	3651 000 0092		3622 000 0092
P85, P100,	55	22	10,26	.404	1,6	.063	3668 000 0069		3946 000 0069
R40, R435, R440	65	26	10,26	.404	1,6	.063	3668 000 0080		3946 000 0080

PEUGEOT

TLS1630, TLS1635,	30	12	9,32	3/8 P	1,3	.050			
TLS1635A, TLS1640	35	14	9,32	3/8 P	1,3	.050			
TRC1630, TRC1635, TRC1640	40	16	9,32	3/8 P	1,3	.050			

PIONEER

P10, P11, P12, P12S	30	12	9,32	3/8 P	1,3	.050			
	35	14	9,32	3/8 P	1,3	.050			
	40	16	9,32	3/8 P	1,3	.050			

970, 1072, 1073, 1074,	33	13	8,25	.325	1,5	.058	3685 000 0056	3688 000 0056	3638 000 0056
P21, P25, P26, P28, P28S	35	14	8,25	.325	1,5	.058	3685 000 0061	3688 000 0061	3638 000 0061
	38	15	8,25	.325	1,5	.058	3685 000 0064	3688 000 0064	3638 000 0064
	40	16	8,25	.325	1,5	.058	3685 000 0066	3688 000 0066	3638 000 0066
	43	17	8,25	.325	1,5	.058	3685 000 0068	3688 000 0068	3638 000 0068
	45	18	8,25	.325	1,5	.058	3685 000 0072	3688 000 0072	3638 000 0072
	50	20	8,25	.325	1,5	.058	3685 000 0078	3688 000 0078	3638 000 0078

RS3

STIHL RAPID
Super 3

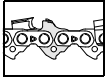

RSK

STIHL RAPID
Super K



RD3

STIHL RAPID
Duro 3

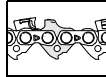

PM

STIHL PICCO
Micro



PD3

STIHL PICCO
Duro 3



PM3

STIHL PICCO
Micro 3

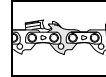

PMM3

STIHL PICCO
Micro Mini 3

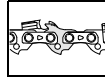

3613 000 0045	3612 000 0045	3636 000 0045
3613 000 0052	3612 000 0052	3636 000 0052
3613 000 0056	3612 000 0056	3636 000 0056

3613 000 0052	3612 000 0052	3636 000 0052
3613 000 0056	3612 000 0056	3636 000 0056

3893 000 0050
3893 000 0056

3893 000 0052
3893 000 0056
3893 000 0060
3893 000 0064
3893 000 0072
3893 000 0076

3893 000 0060
3893 000 0068
3893 000 0072
3893 000 0077
3893 000 0084
3893 000 0089
3893 000 0092

3846 000 0069
3846 000 0080

3613 000 0045	3612 000 0045	3636 000 0045
3613 000 0050	3612 000 0050	3636 000 0050
3613 000 0056	3612 000 0056	3636 000 0056

3613 000 0045	3612 000 0045	3636 000 0045
3613 000 0052	3612 000 0052	3636 000 0052
3613 000 0056	3612 000 0056	3636 000 0056

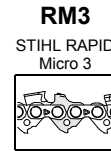
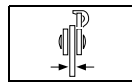
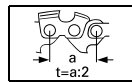
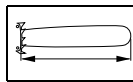

P25, P 38SS, P40, P41, P41S, P42HP, P42S, P50, P51, P51S, P52S, P60, P61, P61S, P62S, FARM-SAW II, FARMLITE, FARM SAWS	35 40 45 50 60	14 16 18 20 24	9,32 9,32 9,32 9,32 9,32	3/8 3/8 3/8 3/8 3/8	1,5 1,5 1,5 1,5 1,5	.058 .058 .058 .058 .058	3651 000 0053 3651 000 0061 3651 000 0068 3651 000 0072 3651 000 0084		3622 000 0053 3622 000 0061 3622 000 0068 3622 000 0072 3622 000 0084
---	----------------------------	----------------------------	--------------------------------------	---------------------------------	---------------------------------	--------------------------------------	---	--	---

1100, 1200, 1200A, 1400, 1700, 1800, 2270, 2400, 3071, 3200, 3270 AUTO, 3280 AUTO, 400, 540, 600, 620, 650, 700, P20NU17	40 50 60 70	16 20 24 28	9,32 9,32 9,32 9,32	3/8 3/8 3/8 3/8	1,5 1,5 1,5 1,5	.058 .058 .058 .058	3900 000 0062 3900 000 0070 3900 000 0079 3900 000 0092		3622 000 0062 3622 000 0070 3622 000 0079 3622 000 0092
--	----------------------	----------------------	------------------------------	--------------------------	--------------------------	------------------------------	--	--	--

P50CP, P51S, P60, P61, P61S	50 60 70 90	20 24 28 36	10,26 10,26 10,26 10,26	.404 .404 .404 .404	1,5 1,5 1,5 1,5	.058 .058 .058 .058			3924 000 0064 3924 000 0072 3924 000 0084 3924 000 0100
--------------------------------	----------------------	----------------------	----------------------------------	------------------------------	--------------------------	------------------------------	--	--	--

POULAN

25A, S25D, S25DA, S25CVA, 2000, 2300AV, MICRO 25, P600, 2300CVA	30 35 40	12 14 16	9,32 9,32 9,32	3/8 P 3/8 P 3/8 P	1,3 1,3 1,3	.050 .050 .050			
--	----------------	----------------	----------------------	-------------------------	-------------------	----------------------	--	--	--

1800	30 35 40	12 14 16	9,32 9,32 9,32	3/8 P 3/8 P 3/8 P	1,3 1,3 1,3	.050 .050 .050			
------	----------------	----------------	----------------------	-------------------------	-------------------	----------------------	--	--	--

1400E	35	14	9,32	3/8 P	1,3	.050			
-------	----	----	------	-------	-----	------	--	--	--

200 SERIES, 245	33	13	8,25	.325	1,5	.058	3685 000 0056	3688 000 0056	3638 000 0056
-----------------	----	----	------	------	-----	------	---------------	---------------	---------------

300 SERIES, 306, 360, 361, 3400, 3700, 400 SERIES, 4000, 4200	33 40 50	13 16 20	9,32 9,32 9,32	3/8 3/8 3/8	1,3 1,3 1,3	.050 .050 .050	3650 000 0052 3650 000 0060 3650 000 0070		3623 000 0052 3623 000 0060 3623 000 0070
--	----------------	----------------	----------------------	-------------------	-------------------	----------------------	---	--	---

4400, 4900, 5200, 5400	33	13	9,32	3/8	1,5	.058	3651 000 0052		3622 000 0052
---------------------------	----	----	------	-----	-----	------	---------------	--	---------------

5500, 6000	43 53	17 21	10,26 10,26	.404 .404	1,6 1,6	.063 .063	3668 000 0061 3668 000 0070		3946 000 0061 3946 000 0070
------------	----------	----------	----------------	--------------	------------	--------------	--------------------------------	--	--------------------------------

POWER PRUNER

PP600, PP800, PP1000, PP1250	25	10	9,32	3/8 P	1,3	.050			
---------------------------------	----	----	------	-------	-----	------	--	--	--

PS

180, 190	45	18	10,26	.404	1,6	.063	3668 000 0060		3946 000 0060
----------	----	----	-------	------	-----	------	---------------	--	---------------

QUADRA FRONTIER

	30 35 40	12 14 16	9,32 9,32 9,32	3/8 P 3/8 P 3/8 P	1,3 1,3 1,3	.050 .050 .050			
--	----------------	----------------	----------------------	-------------------------	-------------------	----------------------	--	--	--

RELEX

R51AVB, R61AVB	40 45 50	16 18 20	9,32 9,32 9,32	3/8 3/8 3/8	1,5 1,5 1,5	.058 .058 .058	3651 000 0060 3651 000 0068 3651 000 0072		3622 000 0060 3622 000 0068 3622 000 0072
----------------	----------------	----------------	----------------------	-------------------	-------------------	----------------------	---	--	---

RS3

STIHL RAPID
Super 3

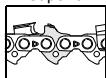

RSK

STIHL RAPID
Super K



RD3

STIHL RAPID
Duro 3

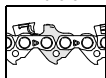

PM

STIHL PICCO
Micro



PD3

STIHL PICCO
Duro 3

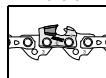

PM3

STIHL PICCO
Micro 3

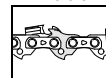

PMM3

STIHL PICCO
Micro Mini 3

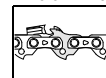

3893 000 0053
3893 000 0061
3893 000 0068
3893 000 0072
3893 000 0084

3893 000 0062
3893 000 0070
3893 000 0079
3893 000 0092

3613 000 0045 3612 000 0045 3636 000 0045
3613 000 0052 3612 000 0052 3636 000 0052
3613 000 0057 3612 000 0057 3636 000 0057

3612 000 0045 3636 000 0045
3612 000 0052 3636 000 0052
3612 000 0057 3636 000 0057

3613 000 0052 3612 000 0052 3636 000 0052

3624 000 0052 3874 000 0052 3681 000 0052
3624 000 0060 3874 000 0060 3681 000 0060
3624 000 0070 3874 000 0070 3681 000 0070

3893 000 0052

3846 000 0061
3846 000 0070

3613 000 0039 3612 000 0039 3636 000 0039

3846 000 0060

3613 000 0045 3612 000 0045 3636 000 0045
3613 000 0052 3612 000 0052 3636 000 0052
3613 000 0056 3612 000 0056 3636 000 0056

3893 000 0060
3893 000 0068
3893 000 0072

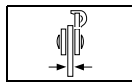
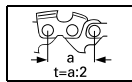
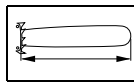

RM STIHL RAPID Micro



RM3 STIHL RAPID Micro 3

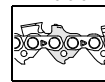

RS STIHL RAPID Super



	cm	in.	mm	in.	mm	in.			
LIMB'N TRIM,	20	8	6,35	1/4	1,3	.050	3660 000 0048		
MIGHTY MITE,	25	10	6,35	1/4	1,3	.050	3660 000 0056		
MIGHTY MITE ELEC	30	12	6,35	1/4	1,3	.050	3660 000 0064		
	35	14	6,35	1/4	1,3	.050	3660 000 0072		
"FAST SHARP",	20	8	9,32	3/8 P	1,3	.050			
860AV,	25	10	9,32	3/8 P	1,3	.050			
EL6 DE LUXE,	30	12	9,32	3/8 P	1,3	.050			
ELECTRIC POWER,	35	14	9,32	3/8 P	1,3	.050			
LIMB'N TRIM,	40	16	9,32	3/8 P	1,3	.050			
CUTTER,									
YARDMASTER,									
(FAST SHARP),									
EL6 STANDARD,									
EL6 SUPER									
MIGHTY MITE: 100,	20	8	9,32	3/8 P	1,3	.050			
200, 300, 400,	25	10	9,32	3/8 P	1,3	.050			
500, 812, 814,	30	12	9,32	3/8 P	1,3	.050			
816, 816AV,	35	14	9,32	3/8 P	1,3	.050			
840AV, 850AV	40	16	9,32	3/8 P	1,3	.050			
PL4, PL5, PL5A, PL6,	38	15	9,32	3/8	1,3	.050	3650 000 0056		3623 000 0056
PL6A, PL7, PL7A,	48	19	9,32	3/8	1,3	.050	3650 000 0068		3623 000 0068
PL55, PL55A,	58	23	9,32	3/8	1,3	.050	3650 000 0078		3623 000 0078
SL9, SL9A, SL10, SL4,	66	26	9,32	3/8	1,3	.050	3650 000 0085		3623 000 0085
SL10A, SL11A									
SL14, SL16	45	18	10,26	.404	1,5	.058			3924 000 0062
	53	21	10,26	.404	1,5	.058			3924 000 0072
	60	24	10,26	.404	1,5	.058			3924 000 0079
	75	30	10,26	.404	1,5	.058			3924 000 0092
RETEZAT									
All models	43	17	9,32	3/8	1,5	.058	3651 000 0066		3622 000 0066
	43	17	10,26	.404	1,5	.058			3924 000 0060
RYOBI									
35B, CS36C, CS41,	30	12	9,32	3/8 P	1,3	.050			
CS384CB, CS385CB,	35	14	9,32	3/8 P	1,3	.050			
CSE3330,	40	16	9,32	3/8 P	1,3	.050			
HC31, HCS31, HC36,									
HCS36, HC41, CS1530,									
CS1535, CS1540,									
RCS4040CA									
CSN410	40	16	9,32	3/8 P	1,3	.050			
CSE 5145, CSE 5650	40	16	8,25	.325	1,5	.058	3685 000 0068	3688 000 0068	3638 000 0068
	45	18	8,25	.325	1,5	.058	3685 000 0072	3688 000 0072	3638 000 0072
	50	20	8,25	.325	1,5	.058	3685 000 0080	3688 000 0080	3638 000 0080
SAUER									
ZKS 33, ZKS 2033	35	14	8,25	.325	1,3	.050	3684 000 0061	3687 000 0061	3637 000 0061
ZKS 33, ZKS 2033	35	14	9,32	3/8	1,3	.050	3650 000 0054		3623 000 0054
SHARK									
PL2, PL4	30	12	9,32	3/8 P	1,3	.050			
	35	14	9,32	3/8 P	1,3	.050			
	40	16	9,32	3/8 P	1,3	.050			

RS3

STIHL RAPID
Super 3



RSK

STIHL RAPID
Super K



RD3

STIHL RAPID
Duro 3

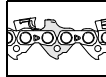

PM

STIHL PICCO
Micro



PD3

STIHL PICCO
Duro 3



PM3

STIHL PICCO
Micro 3

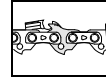

PMM3

STIHL PICCO
Micro Mini 3

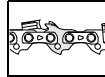

3613 000 0034	3612 000 0034	3636 000 0034
3613 000 0040	3612 000 0040	3636 000 0040
3613 000 0045	3612 000 0045	3636 000 0045
3613 000 0050	3612 000 0050	3636 000 0050
3613 000 0056	3612 000 0056	3636 000 0056

3613 000 0034	3612 000 0034	3636 000 0034
3613 000 0039	3612 000 0039	3636 000 0039
3613 000 0044	3612 000 0044	3636 000 0044
3613 000 0049	3612 000 0049	3636 000 0049
3613 000 0056	3612 000 0056	3636 000 0056

3624 000 0056	3874 000 0056	3681 000 0056
3624 000 0068	3874 000 0068	3681 000 0068
3624 000 0078	3874 000 0078	3681 000 0078
3624 000 0085	3874 000 0085	3681 000 0085

3893 000 0066

3613 000 0044	3612 000 0044	3636 000 0044
3613 000 0049	3612 000 0049	3636 000 0049
3613 000 0055	3612 000 0055	3636 000 0055

3613 000 0056	3612 000 0056	3636 000 0056
---------------	---------------	---------------

3624 000 0054	3874 000 0054	3681 000 0054
---------------	---------------	---------------

3613 000 0044	3612 000 0044	3636 000 0044
3613 000 0049	3612 000 0049	3636 000 0049
3613 000 0055	3612 000 0055	3636 000 0055

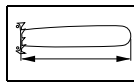

cm in.

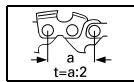

mm in.

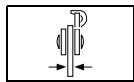

mm in.

RM

STIHL RAPID
Micro



RM3

STIHL RAPID
Micro 3

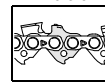

RS

STIHL RAPID
Super



SHINDAIWA / SDK / ISEKI

305AVZ, E305	35	14	6,35	1/4	1,3	.050	3660 000 0076		
	40	16	6,35	1/4	1,3	.050	3660 000 0086		
300, 305, 305AVZ, 340, 30	12	9,32	3/8 P	1,3	.050				
346, 350, 355, 357, 360, 35	14	9,32	3/8 P	1,3	.050				
A090B, A100C, A102, A103, A104P, A105B, A107, A110, A110P, A113, A113L, A113P, A117P, A150B, A180, YB120, YB291, YB301, YB391, YB401, YB491, EYB120, EYB150	40	16	9,32	3/8 P	1,3	.050			
360, 377, 400, 415, 416, 33	13	8,25	.325	1,3	.050	3684 000 0056	3687 000 0056	3637 000 0056	
420, 450, 451, 452S,	40	16	8,25	.325	1,3	.050	3684 000 0066	3687 000 0066	3637 000 0066
488, 500, 510, 560, A180B,	45	18	8,25	.325	1,3	.050	3684 000 0072	3687 000 0072	3637 000 0072
YB377, YB495, YB501,	28	11	8,25	.325	1,5	.058	3685 000 0052	3688 000 0052	3638 000 0052
YB601, YB691, YB701	33	13	8,25	.325	1,5	.058	3685 000 0056	3688 000 0056	3638 000 0056
	35	14	8,25	.325	1,5	.058	3685 000 0060	3688 000 0060	3638 000 0060
	38	15	8,25	.325	1,5	.058	3685 000 0064	3688 000 0064	3638 000 0064
	40	16	8,25	.325	1,5	.058	3685 000 0066	3688 000 0066	3638 000 0066
	45	18	8,25	.325	1,5	.058	3685 000 0072	3688 000 0072	3638 000 0072
575, 577, 680, 695, 757,	40	16	9,32	3/8	1,5	.058	3651 000 0060		3622 000 0060
757C, YB801, YB901,	43	17	9,32	3/8	1,5	.058	3651 000 0064		3622 000 0064
YB1091	45	18	9,32	3/8	1,5	.058	3651 000 0068		3622 000 0068
	50	20	9,32	3/8	1,5	.058	3651 000 0072		3622 000 0072

SHINGU

SP3200T, SP3200,	30	12	9,32	3/8 P	1,3	.050			
SP3400	38	15	9,32	3/8 P	1,3	.050			
	40	16	9,32	3/8 P	1,3	.050			
	40	16	8,25	.325	1,3	.050	3684 000 0066	3687 000 0066	3637 000 0066
	45	18	8,25	.325	1,3	.050	3684 000 0072	3687 000 0072	3637 000 0072

SKIL

1600HE, 1601HE,	30	12	9,32	3/8 P	1,3	.050			
1602HE, 1610U,	35	14	9,32	3/8 P	1,3	.050			
1612U, 1616U,	40	16	9,32	3/8 P	1,3	.050			
1712U									
1603H, 1604H, 1620U,	30	12	9,32	3/8 P	1,3	.050			
1634U, 1636U	35	14	9,32	3/8 P	1,3	.050			
	40	16	9,32	3/8 P	1,3	.050			

SOLO

MULTI-MOT	25	10	6,35	1/4	1,3	.050	3660 000 0058		
	30	12	6,35	1/4	1,3	.050	3660 000 0068		
600, 605VA, 606VA,	30	12	9,32	3/8 P	1,3	.050			
631, 632, 634, 635,	35	14	9,32	3/8 P	1,3	.050			
636, 638, 641, 642, 643, 40	16	9,32	3/8 P	1,3	.050				
FARMER 31,									
FARMER 32,									
FARMER 38									
637	35	14	9,32	3/8 P	1,3	.050			

RS3

STIHL RAPID
Super 3

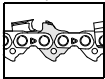

RSK

STIHL RAPID
Super K



RD3

STIHL RAPID
Duro 3

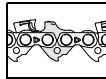

PM

STIHL PICCO
Micro



PD3

STIHL PICCO
Duro 3

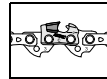

PM3

STIHL PICCO
Micro 3

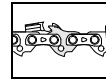

PMM3

STIHL PICCO
Micro Mini 3

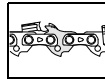

3613 000 0045	3612 000 0045	3636 000 0045
3613 000 0052	3612 000 0052	3636 000 0052
3613 000 0057	3612 000 0057	3636 000 0057

3893 000 0060
3893 000 0064
3893 000 0068
3893 000 0072

3613 000 0045	3612 000 0045	3636 000 0045
3613 000 0052	3612 000 0052	3636 000 0052
3613 000 0057	3612 000 0057	3636 000 0057

3613 000 0045	3612 000 0045	3636 000 0045
3613 000 0052	3612 000 0052	3636 000 0052
3613 000 0056	3612 000 0056	3636 000 0056

3613 000 0045	3612 000 0045	3636 000 0045
3613 000 0052	3612 000 0052	3636 000 0052
3613 000 0057	3612 000 0057	3636 000 0057

3613 000 0047	3612 000 0047	3636 000 0047
3613 000 0053	3612 000 0053	3636 000 0053
3613 000 0058	3612 000 0058	3636 000 0058

3613 000 0053	3612 000 0053	3636 000 0053
---------------	---------------	---------------

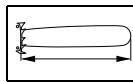

cm in.

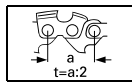

mm in.

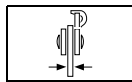

mm in.

RM

STIHL RAPID
Micro



RM3

STIHL RAPID
Micro 3

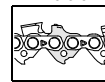

RS

STIHL RAPID
Super



=> SOLO

614E, 634	40	16	9,32	3/8 P	1,3	.050			
610, 611VA, 615, 616VA, FARMER 11, FARMER 16	40	16	8,25	.325	1,3	.050	3684 000 0067	3687 000 0067	3637 000 0067
	45	18	8,25	.325	1,3	.050	3684 000 0073	3687 000 0073	3637 000 0073
634, 639, 641, 643IP, 644, 644SP, 645, 646, 647, 650, 651, 652, 654, 656	33	13	8,25	.325	1,5	.058	3685 000 0057	3688 000 0057	3638 000 0057
	35	14	8,25	.325	1,5	.058	3685 000 0061	3688 000 0061	3638 000 0061
	38	15	8,25	.325	1,5	.058	3685 000 0065	3688 000 0065	3638 000 0065
	40	16	8,25	.325	1,5	.058	3685 000 0067	3688 000 0067	3638 000 0067
	40	16	8,25	.325	1,5	.058	3685 000 0069	3688 000 0069	3638 000 0069
	45	18	8,25	.325	1,5	.058	3685 000 0073	3688 000 0073	3638 000 0073
	50	20	8,25	.325	1,5	.058	3685 000 0079	3688 000 0079	3638 000 0079
620, 630, 640, 645, 650, 655, 660, 70, TWIN, SOLO REX	40	16	9,32	3/8	1,3	.050	3650 000 0060		3623 000 0060
	50	20	9,32	3/8	1,3	.050	3650 000 0071		3623 000 0071
662, 665, 667, 670, 675, 680, 681, 690, 694	33	13	9,32	3/8	1,5	.058	3651 000 0052		3622 000 0052
	38	15	9,32	3/8	1,5	.058	3651 000 0056		3622 000 0056
	40	16	9,32	3/8	1,5	.058	3651 000 0060		3622 000 0060
	43	17	9,32	3/8	1,5	.058	3651 000 0064		3622 000 0064
	45	18	9,32	3/8	1,5	.058	3651 000 0068		3622 000 0068
	50	20	9,32	3/8	1,5	.058	3651 000 0072		3622 000 0072
	55	22	9,32	3/8	1,5	.058	3651 000 0076		3622 000 0076
	60	24	9,32	3/8	1,5	.058	3651 000 0084		3622 000 0084
	65	26	9,32	3/8	1,5	.058	3651 000 0089		3622 000 0089
	70	28	9,32	3/8	1,5	.058	3651 000 0092		3622 000 0092
603, 690	60	24	10,26	.404	1,5	.058			3924 000 0076
	70	28	10,26	.404	1,5	.058			3924 000 0084
	90	36	10,26	.404	1,5	.058			3924 000 0108
635, 642	43	17	10,26	.404	1,6	.063	3668 000 0063		3946 000 0063
	53	21	10,26	.404	1,6	.063	3668 000 0072		3946 000 0072
	63	25	10,26	.404	1,6	.063	3668 000 0082		3946 000 0082

STANLEY

CS04, CS07, CS23	30	12	9,32	3/8 P	1,3	.050			
	35	14	9,32	3/8 P	1,3	.050			
	40	16	9,32	3/8 P	1,3	.050			
CS05, CS06	38	15	8,25	.325	1,5	.058	3685 000 0064	3688 000 0064	3638 000 0064

STEINMAX

CS300, CS360	30	12	9,32	3/8 P	1,3	.050			
	35	14	9,32	3/8 P	1,3	.050			
	40	16	9,32	3/8 P	1,3	.050			
G320AVS, G380AVS	30	12	9,32	3/8 P	1,3	.050			
	35	14	9,32	3/8 P	1,3	.050			

TAS TANAKA

290, 300, ECS 320,	30	12	9,32	3/8 P	1,3	.050			
ECS 330, ECS 350,	35	14	9,32	3/8 P	1,3	.050			
ECS 360, ECS 3301, ECS 3351, ECS 3500	40	16	9,32	3/8 P	1,3	.050			

RS3

STIHL RAPID
Super 3

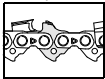

RSK

STIHL RAPID
Super K



RD3

STIHL RAPID
Duro 3

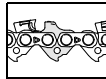

PM

STIHL PICCO
Micro



PD3

STIHL PICCO
Duro 3

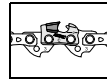

PM3

STIHL PICCO
Micro 3

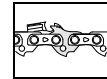

PMM3

STIHL PICCO
Micro Mini 3

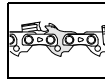

3613 000 0058 3612 000 0058 3636 000 0058

3624 000 0060 3874 000 0060 3681 000 0060
3624 000 0071 3874 000 0071 3681 000 0071

3893 000 0052
3893 000 0056
3893 000 0060
3893 000 0064
3893 000 0068
3893 000 0072
3893 000 0076
3893 000 0084
3893 000 0089
3893 000 0092

3846 000 0063
3846 000 0072
3846 000 0082

3613 000 0044 3612 000 0044 3636 000 0044
3613 000 0049 3612 000 0049 3636 000 0049
3613 000 0055 3612 000 0055 3636 000 0055

3613 000 0045 3612 000 0045 3636 000 0045
3613 000 0052 3612 000 0052 3636 000 0052

3613 000 0045 3612 000 0045 3636 000 0045
3613 000 0052 3612 000 0052 3636 000 0052
3613 000 0057 3612 000 0057 3636 000 0057

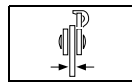
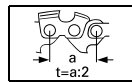
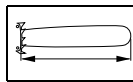

RM STIHL RAPID Micro



RM3 STIHL RAPID Micro 3

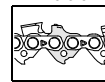

RS STIHL RAPID Super



=> TAS TANAKA

ECS4000	28	11	8,25	.325	1,5	.058	3685 000 0052	3688 000 0052	3638 000 0052
ECV4501	33	13	8,25	.325	1,5	.058	3685 000 0056	3688 000 0056	3638 000 0056
	35	14	8,25	.325	1,5	.058	3685 000 0060	3688 000 0060	3638 000 0060
	38	15	8,25	.325	1,5	.058	3685 000 0064	3688 000 0064	3638 000 0064
	40	16	8,25	.325	1,5	.058	3685 000 0066	3688 000 0066	3638 000 0066
	40	16	8,25	.325	1,5	.058	3685 000 0068	3688 000 0068	3638 000 0068
	45	18	8,25	.325	1,5	.058	3685 000 0072	3688 000 0072	3638 000 0072
	50	20	8,25	.325	1,5	.058	3685 000 0080	3688 000 0080	3638 000 0080

650, ECS 506, 655	33	13	9,32	3/8	1,3	.050	3650 000 0052		3623 000 0052
	40	16	9,32	3/8	1,3	.050	3650 000 0060		3623 000 0060
	45	18	9,32	3/8	1,3	.050	3650 000 0064		3623 000 0064
	45	18	9,32	3/8	1,3	.050	3650 000 0066		3623 000 0066
	50	20	9,32	3/8	1,3	.050	3650 000 0070		3623 000 0070

TECHNIK TOOL

PP1000	26	10	9,32	3/8 P	1,3	.050			
--------	----	----	------	-------	-----	------	--	--	--

TOPSO

E500AV, E510AVB,	33	13	9,32	3/8	1,5	.058	3651 000 0052		3622 000 0052
E600AV, E601AV,	38	15	9,32	3/8	1,5	.058	3651 000 0056		3622 000 0056
E610AVB, E611AVB,	40	16	9,32	3/8	1,5	.058	3651 000 0060		3622 000 0060
E700AV, E710AVB	45	18	9,32	3/8	1,5	.058	3651 000 0068		3622 000 0068
	50	20	9,32	3/8	1,5	.058	3651 000 0072		3622 000 0072

URAL

All models	50	20	10,26	.404	1,6	.063	3668 000 0064		3946 000 0064
------------	----	----	-------	------	-----	------	---------------	--	---------------

VAP

35F, 38, 40F, 44F, 52F,	30	12	9,32	3/8 P	1,3	.050			
60F, 530, 534, 535,	35	14	9,32	3/8 P	1,3	.050			
538, 1400	40	16	9,32	3/8 P	1,3	.050			

14F, 68F, 542	28	11	8,25	.325	1,5	.058	3685 000 0052	3688 000 0052	3638 000 0052
	33	13	8,25	.325	1,5	.058	3685 000 0056	3688 000 0056	3638 000 0056
	35	14	8,25	.325	1,5	.058	3685 000 0060	3688 000 0060	3638 000 0060
	38	15	8,25	.325	1,5	.058	3685 000 0064	3688 000 0064	3638 000 0064
	40	16	8,25	.325	1,5	.058	3685 000 0066	3688 000 0066	3638 000 0066
	43	17	8,25	.325	1,5	.058	3685 000 0068	3688 000 0068	3638 000 0068
	45	18	8,25	.325	1,5	.058	3685 000 0072	3688 000 0072	3638 000 0072
	50	20	8,25	.325	1,5	.058	3685 000 0078	3688 000 0078	3638 000 0078

49, 50E, 55, 65F, 69E,	40	16	9,32	3/8	1,5	.058	3651 000 0060		3622 000 0060
70, 72F, 72FS, 82F,	45	18	9,32	3/8	1,5	.058	3651 000 0068		3622 000 0068
90F, 549, 553, 553S,	50	20	9,32	3/8	1,5	.058	3651 000 0072		3622 000 0072
555, 570	58	23	9,32	3/8	1,5	.058	3651 000 0080		3622 000 0080
	63	25	9,32	3/8	1,5	.058	3651 000 0088		3622 000 0088
	75	30	9,32	3/8	1,5	.058	3651 000 0098		3622 000 0098

	40	16	10,26	.404	1,5	.058			
	45	18	10,26	.404	1,5	.058			
	50	20	10,26	.404	1,5	.058			
	58	23	10,26	.404	1,5	.058			

WEN

All models	30	12	9,32	3/8 P	1,3	.050			
	35	14	9,32	3/8 P	1,3	.050			
	40	16	9,32	3/8 P	1,3	.050			

RS3

STIHL RAPID
Super 3

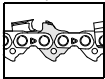

RSK

STIHL RAPID
Super K



RD3

STIHL RAPID
Duro 3

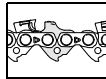

PM

STIHL PICCO
Micro



PD3

STIHL PICCO
Duro 3

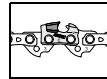

PM3

STIHL PICCO
Micro 3

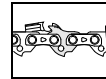

PMM3

STIHL PICCO
Micro Mini 3

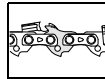

3624 000 0052	3874 000 0052	3681 000 0052
3624 000 0060	3874 000 0060	3681 000 0060
3624 000 0064	3874 000 0064	3681 000 0064
3624 000 0066	3874 000 0066	3681 000 0066
3624 000 0070	3874 000 0070	3681 000 0070

3613 000 0039 3612 000 0039 3636 000 0039

3893 000 0052
3893 000 0056
3893 000 0060
3893 000 0068
3893 000 0072

3846 000 0064

3613 000 0044 3612 000 0044 3636 000 0044
3613 000 0049 3612 000 0049 3636 000 0049
3613 000 0056 3612 000 0056 3636 000 0056

3893 000 0060
3893 000 0068
3893 000 0072
3893 000 0080
3893 000 0088
3893 000 0098

3613 000 0047 3612 000 0047 3636 000 0047
3613 000 0053 3612 000 0053 3636 000 0053
3613 000 0058 3612 000 0058 3636 000 0058

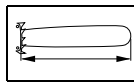

cm in.

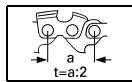

mm in.

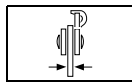

mm in.

RM

STIHL RAPID
Micro



RM3

STIHL RAPID
Micro 3

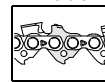

RS

STIHL RAPID
Super



ZENOAH

GZ3900EZ	35	14	6,35	1/4	1,3	.050	3660 000 0076		
	40	16	6,35	1/4	1,3	.050	3660 000 0084		
G300AVS, G300T, G310TS, G3800, GT250, GT310-12	30	12	9,32	3/8 P	1,3	.050			
	35	14	9,32	3/8 P	1,3	.050			
	40	16	9,32	3/8 P	1,3	.050			
GZ3900EZ	35	14	9,32	3/8 P	1,3	.050			
	35	14	8,25	.325	1,3	.050	3684 000 0060	3687 000 0060	3637 000 0060
	40	16	8,25	.325	1,3	.050	3684 000 0066	3687 000 0066	3637 000 0066
	35	14	8,25	.325	1,5	.058	3685 000 0060	3688 000 0060	3638 000 0060
	40	16	8,25	.325	1,5	.058	3685 000 0066	3688 000 0066	3638 000 0066
GZ4300EZ	40	16	8,25	.325	1,3	.050	3684 000 0066	3687 000 0066	3637 000 0066
	44	18	8,25	.325	1,3	.050	3684 000 0072	3687 000 0072	3637 000 0072
	40	16	8,25	.325	1,5	.058	3685 000 0066	3688 000 0066	3638 000 0066
	44	18	8,25	.325	1,5	.058	3685 000 0072	3688 000 0072	3638 000 0072
G380AVS, G410AVS, G455AVS, G500AVS	30	12	8,25	.325	1,3	.050	3684 000 0054	3687 000 0054	3637 000 0054
	33	13	8,25	.325	1,3	.050	3684 000 0056	3687 000 0056	3637 000 0056
	38	15	8,25	.325	1,3	.050	3684 000 0064	3687 000 0064	3637 000 0064
	40	16	8,25	.325	1,3	.050	3684 000 0066	3687 000 0066	3637 000 0066
	45	18	8,25	.325	1,3	.050	3684 000 0072	3687 000 0072	3637 000 0072
	50	20	8,25	.325	1,3	.050	3684 000 0078	3687 000 0078	3637 000 0078
G561AVS	40	16	8,25	.325	1,5	.058	3685 000 0066	3688 000 0066	3638 000 0066
	45	18	8,25	.325	1,5	.058	3685 000 0072	3688 000 0072	3638 000 0072
	50	20	8,25	.325	1,5	.058	3685 000 0081	3688 000 0081	3638 000 0081
G621 AVS	33	13	9,32	3/8	1,5	.058	3651 000 0052		3622 000 0052
	40	16	9,32	3/8	1,5	.058	3651 000 0060		3622 000 0060
	45	18	9,32	3/8	1,5	.058	3651 000 0064		3622 000 0064
	50	20	9,32	3/8	1,5	.058	3651 000 0072		3622 000 0072

RS3

STIHL RAPID
Super 3

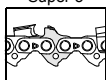

RSK

STIHL RAPID
Super K



RD3

STIHL RAPID
Duro 3

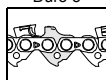

PM

STIHL PICCO
Micro



PD3

STIHL PICCO
Duro 3

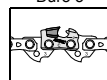

PM3

STIHL PICCO
Micro 3

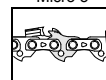

PMM3

STIHL PICCO
Micro Mini 3

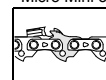

3613 000 0046	3612 000 0046	3636 000 0046
3613 000 0052	3612 000 0052	3636 000 0052
3613 000 0057	3612 000 0057	3636 000 0057

3613 000 0052	3612 000 0052	3636 000 0052
---------------	---------------	---------------

3893 000 0052
3893 000 0060
3893 000 0064
3893 000 0072

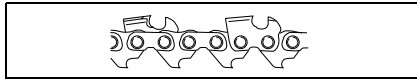

STIHL

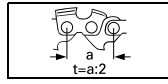

mm in.

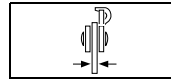

mm in.

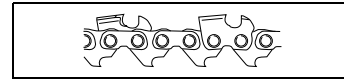

Oregon Carlton

STIHL				mm	in.	mm	in.	Oregon	Carlton
Rapid	Micro	13 RM	3660	6,35	1/4	1,3	.050	25AP	E1MC-BL
Rapid	Micro	13 RMS	3661	6,35	1/4	1,3	.050	25A, 25F	
Rapid	Micro	23 RM	3684	8,25	.325	1,3	.050	20BPX, 95TXL	K1C
Rapid	Micro 3	23 RM3	3687	8,25	.325	1,3	.050	20BPX	K1L-BL
Rapid	Super	23 RS	3637	8,25	.325	1,3	.050	20LPX	K1L
Rapid	Duro	23 RD3	3665	8,25	.325	1,3	.050	M20LPX	-
Rapid	Micro	25 RM	3685	8,25	.325	1,5	.058	21BPX	K2C
Rapid	Micro 3	25 RM3	3688	8,25	.325	1,5	.058	21BPX	K2C-BL
Rapid	Super	25 RS	3638	8,25	.325	1,5	.058	21LPX	K2L
Rapid	Duro	25 RD3	3666	8,25	.325	1,5	.058	M21LPX	-
Rapid	Micro	26 RM	3686	8,25	.325	1,6	.063	22BPX	K3C
Rapid	Micro 3	26 RM3	3689	8,25	.325	1,6	.063	22BPX	K3C-BL
Rapid	Super	26 RS	3639	8,25	.325	1,6	.063	22LPX	K3L
Rapid	Duro	26 RD3	3667	8,25	.325	1,6	.063	M22LPX	-
Picco	Micro Mini 3	61 PMM3	3610	9,32	3/8 P	1,1	.043	90PX	N4C-BL
Picco	Micro	63 PM	3613	9,32	3/8 P	1,3	.050	91VXL	N1C
Picco	Micro 3	63 PM3	3636	9,32	3/8 P	1,3	.050	91PX, 91PXL	N1C-BL
Picco	Micro X	63 PMX	3614	9,32	3/8 P	1,3	.050	91R	-
Picco	Duro	63 PD3	3612	9,32	3/8 P	1,3	.050	M91VXL	-
Rapid	Micro	33 RM	3989	9,32	3/8	1,3	.050	72DPX	A1EP
Rapid	Micro F	33 RMF	3654	9,32	3/8	1,3	.050	72APX	-
Rapid	Super	33 RS	3623	9,32	3/8	1,3	.050	72LPX, 72LGX	A1LM
Rapid	Super 3	33 RS3	3624	9,32	3/8	1,3	.050	72V	A1LM-GL
Rapid	Super K	33 RSK	3874	9,32	3/8	1,3	.050	72LPX	-
Rapid	Super L	33 RSL	3679	9,32	3/8	1,3	.050	72CL, 72CLX	-
Rapid	Super F	33 RSF	3676	9,32	3/8	1,3	.050	72JGX, 72JPX	A1LM-SK
Rapid	Super LF	33 RSLF	3672	9,32	3/8	1,3	.050	72CJ, 72CJX	-
Rapid	Super LH	33 RSLH	3674	9,32	3/8	1,3	.050	72CK, 72CKX	-
Rapid	Duro	33 RD3	3681	9,32	3/8	1,3	.050	M72LPX	-
Rapid	Micro	35 RM	3990	9,32	3/8	1,5	.058	73DPX	A2EP
Rapid	Super	35 RS	3622	9,32	3/8	1,5	.058	73LPX, 73LGX	A2LM
Rapid	Super K	35 RSK	3893	9,32	3/8	1,5	.058	73LPX	-
Rapid	Super F	35 RSF	3677	9,32	3/8	1,5	.058	73JGX, 73JPX	A2L-SK
Rapid	Duro	35 RD3	3682	9,32	3/8	1,5	.063	M73LPX	-
Rapid	Micro	36 RM	3991	9,32	3/8	1,6	.063	75DPX	A3EP
Rapid	Micro X	36 RMX	3653	9,32	3/8	1,6	.063	75RD	-
Rapid	Super 3	36 RS3	3626	9,32	3/8	1,6	.063	75LV	A3LM-GL
Rapid	Super	36 RS	3621	9,32	3/8	1,6	.063	75LPX, 75LGX	-
Rapid	Super K	36 RSK	3898	9,32	3/8	1,6	.063	75LPX	-
Rapid	Super L	36 RSL	3680	9,32	3/8	1,6	.063	75CL	-
Rapid	Super F	36 RSF	3678	9,32	3/8	1,6	.063	75JGX, 75JPX	A3LM-SK
Rapid	Super LF	36 RSLF	3673	9,32	3/8	1,6	.063	75CJ, 75CJX	-
Rapid	Super LH	36 RSLH	3675	9,32	3/8	1,6	.063	75CK, 75CKX	-
Rapid	Duro	36 RD3	3683	9,32	3/8	1,6	.063	M75LPX	-

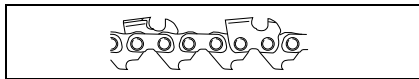

STIHL

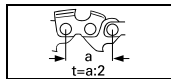

mm in.

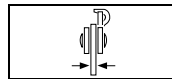

mm in.

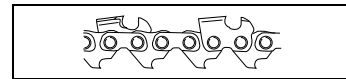

Oregon

Carlton

STIHL		Oregon		Carlton				
Rapid Super F	45 RSF	3924	10,26	.404	1,5	.058	58J	B2LM-SK
Rapid Standard	46 RC	3957	10,26	.404	1,6	.063	-	-
Rapid Standard K	46 RCK	3812	10,26	.404	1,6	.063	-	-
Rapid Standard X	46 RCX	3958	10,26	.404	1,6	.063	-	-
Rapid Micro	46 RM	3668	10,26	.404	1,6	.063	27X	B3S
Rapid Micro K	46 RMK	3860	10,26	.404	1,6	.063	27X	B3S
Rapid Micro F	46 RMF	3671	10,26	.404	1,6	.063	27AX	-
Rapid Micro X	46 RMX	3838	10,26	.404	1,6	.063	-	B3H-RP
Rapid Super	46 RS	3946	10,26	.404	1,6	.063	59L, 68LX	B3LM
Rapid Super K	46 RSK	3846	10,26	.404	1,6	.063	59L, 68LX	-
Rapid Super L	46 RSL	3877	10,26	.404	1,6	.063	68CL	-
Rapid Super F	46 RSF	3911	10,26	.404	1,6	.063	59J, 68JX	B3LM-SK
Rapid Super LF	46 RSLF	3851	10,26	.404	1,6	.063	59CJ	-

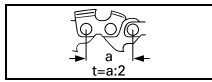

mm in

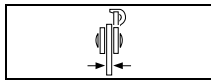

mm in

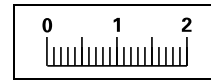
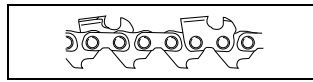

m ft

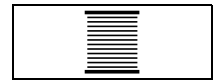

6,35	1/4 P	1,1	.043	3670	71 PM3	30,4	100	3670 000 2400
6,35	1/4	1,3	.050	3660	13 RM	30,4	100	3660 000 2400
6,35	1/4	1,3	.050	3661	13 RMS	30,4	100	3661 000 2400
8,25	.325	1,3	.050	3684	23 RM	30,4	100	3684 000 1840
8,25	.325	1,3	.050	3687	23 RM3	30,4	100	3687 000 1840
8,25	.325	1,3	.050	3637	23 RS	30,4	100	3637 000 1840
8,25	.325	1,3	.050	3665	23 RD3	7,6	25	3665 000 0460
8,25	.325	1,3	.050	3665	23 RD3	30,4	100	3665 000 1840
8,25	.325	1,5	.058	3685	25 RM	30,4	100	3685 000 1840
8,25	.325	1,5	.058	3688	25 RM3	30,4	100	3688 000 1840
8,25	.325	1,5	.058	3638	25 RS	30,4	100	3638 000 1840
8,25	.325	1,5	.058	3666	25 RD3	7,6	25	3666 000 0460
8,25	.325	1,5	.058	3666	25 RD3	30,4	100	3666 000 1840
8,25	.325	1,6	.063	3686	26 RM	30,4	100	3686 000 1840
8,25	.325	1,6	.063	3689	26 RM3	30,4	100	3689 000 1840
8,25	.325	1,6	.063	3639	26 RS	30,4	100	3639 000 1840
8,25	.325	1,6	.063	3667	26 RD3	7,6	25	3667 000 0460
8,25	.325	1,6	.063	3667	26 RD3	30,4	100	3667 000 1840
9,32	3/8 P	1,3	.050	3613	63 PM	30,4	100	3613 000 1640
9,32	3/8 P	1,3	.050	3636	63 PM3	30,4	100	3636 000 1640
9,32	3/8 P	1,3	.050	3617	63 PS	30,4	100	3617 000 1640
9,32	3/8 P	1,3	.050	3616	63 PS3	30,4	100	3616 000 1640
9,32	3/8 P	1,1	.043	3610	61 PMM3	30,4	100	3610 000 1640
9,32	3/8 P	1,3	.050	3614	63 PMX	30,4	100	3614 000 1640
9,32	3/8 P	1,3	.050	3615	63 PMY	30,4	100	3615 000 1640
9,32	3/8 P	1,3	.050	3612	63 PD3	7,6	25	3612 000 0410
9,32	3/8 P	1,3	.050	3612	63 PD3	30,4	100	3612 000 01640
9,32	3/8	1,3	.050	3650	33 RM	30,4	100	3650 000 1640
9,32	3/8	1,3	.050	3662	33 RM3	30,4	100	3662 000 1640
9,32	3/8	1,3	.050	3654	33 RMF	30,4	100	3654 000 1640
9,32	3/8	1,3	.050	3623	33 RS	30,4	100	3623 000 1640
9,32	3/8	1,3	.050	3624	33 RS3	30,4	100	3624 000 1640
9,32	3/8	1,3	.050	3874	33 RSK	30,4	100	3874 000 1640
9,32	3/8	1,3	.050	3676	33 RSF	30,4	100	3676 000 1640
9,32	3/8	1,3	.050	3679	33 RSL	30,4	100	3679 000 1640
9,32	3/8	1,3	.050	3674	33 RSLH	30,4	100	3674 000 1640

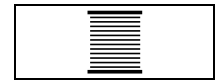
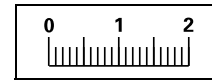
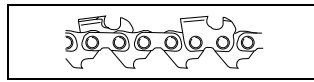
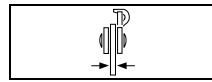
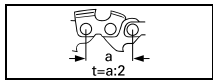

mm	in	mm	in	mm	in	m	ft	mm	in
9,32	3/8	1,3	.050	3672	33 RSLF	30,4	100	3672 000	1640
9,32	3/8	1,3	.050	3681	33 RD3	7,6	25	3681 000	0410
9,32	3/8	1,3	.050	3681	33 RD3	30,4	100	3681 000	1640
9,32	3/8	1,5	.058	3651	35 RM	30,4	100	3651 000	1640
9,32	3/8	1,5	.058	3622	35 RS	30,4	100	3622 000	1640
9,32	3/8	1,5	.058	3677	35 RSF	30,4	100	3677 000	1640
9,32	3/8	1,5	.058	3682	35 RD3	7,6	25	3682 000	0410
9,32	3/8	1,5	.058	3682	35 RD3	30,4	100	3682 000	1640
9,32	3/8	1,6	.063	3652	36 RM	30,4	100	3652 000	1640
9,32	3/8	1,6	.063	3664	36 RM3	30,4	100	3664 000	1640
9,32	3/8	1,6	.063	3653	36 RMX	30,4	100	3653 000	1640
9,32	3/8	1,6	.063	3621	36 RS	30,4	100	3621 000	1640
9,32	3/8	1,6	.063	3626	36 RS3	30,4	100	3626 000	1640
9,32	3/8	1,6	.063	3898	36 RSK	30,4	100	3898 000	1640
9,32	3/8	1,6	.063	3678	36 RSF	30,4	100	3678 000	1640
9,32	3/8	1,6	.063	3680	36 RSL	30,4	100	3680 000	1640
9,32	3/8	1,6	.063	3675	36 RSLH	30,4	100	3675 000	1640
9,32	3/8	1,6	.063	3673	36 RSLF	30,4	100	3673 000	1640
9,32	3/8	1,6	.063	3683	36 RD3	7,6	25	3683 000	0410
9,32	3/8	1,6	.063	3683	36 RD3	30,4	100	3683 000	1640
10,26	.404	1,5	.058	3924	45 RSF	30,4	100	3924 000	1480
10,26	.404	1,6	.063	3812	46 RCK	30,4	100	3812 000	1480
10,26	.404	1,6	.063	3958	46 RCX	30,4	100	3958 000	1480
10,26	.404	1,6	.063	3895	46 RCXK	30,4	100	3895 000	1480
10,26	.404	1,6	.063	3668	46 RM	30,4	100	3668 000	1480
10,26	.404	1,6	.063	3860	46 RMK	30,4	100	3860 000	1480
10,26	.404	1,6	.063	3838	46 RMX	30,4	100	3838 000	1480
10,26	.404	1,6	.063	3671	46 RMF	30,4	100	3671 000	1480
10,26	.404	1,6	.063	3946	46 RS	30,4	100	3946 000	1480
10,26	.404	1,6	.063	3846	46 RSK	30,4	100	3846 000	1480
10,26	.404	1,6	.063	3911	46 RSF	30,4	100	3911 000	1480
10,26	.404	1,6	.063	3851	46 RSLF	30,4	100	3851 000	1480

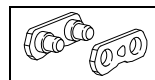
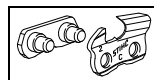
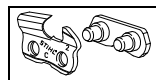
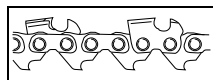
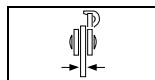
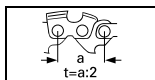

mm	in	mm	in					
6,35	1/4 P	1,1	.043	3670	71 PM3	3669 007 1000 ¹	3669 007 1001 ²	3669 660 6000 ⁵
6,35	1/4	1,3	.050	3660	13 RM	3660 007 1000 ¹	3660 007 1001 ²	3660 660 6000 ⁵
6,35	1/4	1,3	.050	3661	13 RMS	3661 007 1000 ¹	3661 007 1001 ²	3660 660 6000 ⁵
8,25	.325	1,3	.050	3684	23 RM	3686 007 1000 ¹	3686 007 1001 ²	3686 660 6000 ³
8,25	.325	1,3	.050	3687	23 RM3	3686 007 1000 ¹	3686 007 1001 ²	3686 660 6000 ³
8,25	.325	1,3	.050	3637	23 RS	3639 007 1000 ¹	3639 007 1001 ²	3686 660 6000 ³
8,25	.325	1,3	.050	3665	23 RD3	3667 007 1000 ¹	3667 007 1001 ²	3686 660 6000 ³
8,25	.325	1,5	.058	3685	25 RM	3686 007 1000 ¹	3686 007 1001 ²	3686 660 6000 ³
8,25	.325	1,5	.058	3688	25 RM3	3686 007 1000 ¹	3686 007 1001 ²	3686 660 6000 ³
8,25	.325	1,5	.058	3638	25 RS	3639 007 1000 ¹	3639 007 1001 ²	3686 660 6000 ³
8,25	.325	1,5	.058	3666	25 RD3	3667 007 1000 ¹	3667 007 1001 ²	3686 660 6000 ³
8,25	.325	1,6	.063	3686	26 RM	3686 007 1000 ¹	3686 007 1001 ²	3686 660 6000 ³
8,25	.325	1,6	.063	3689	26 RM3	3686 007 1000 ¹	3686 007 1001 ²	3686 660 6000 ³
8,25	.325	1,6	.063	3639	26 RS	3639 007 1000 ¹	3639 007 1001 ²	3686 660 6000 ³
8,25	.325	1,6	.063	3667	26 RD3	3667 007 1000 ¹	3667 007 1001 ²	3686 660 6000 ³
9,32	3/8 P	1,3	.050	3612	63 PD3	3612 007 1000 ¹	3612 007 1001 ²	3997 660 6020 ⁴
9,32	3/8 P	1,3	.050	3636	63 PM3	3636 007 1000 ¹	3636 007 1001 ²	3997 660 6020 ⁴
9,32	3/8 P	1,3	.050	3613	63 PM	3636 007 1000 ¹	3636 007 1001 ²	3997 660 6020 ⁴
9,32	3/8 P	1,3	.050	3614	63 PMX	3614 007 1000 ¹	3614 007 1001 ²	3997 660 6020 ⁴
9,32	3/8 P	1,3	.050	3615	63 PMY	3636 007 1000 ¹	3636 007 1001 ²	3997 660 6020 ⁴
9,32	3/8 P	1,3	.050	3617	63 PS	3616 007 1000 ¹	3616 007 1001 ²	3997 660 6020 ⁴
9,32	3/8 P	1,3	.050	3616	63 PS3	3616 007 1000 ¹	3616 007 1001 ²	3997 660 6020 ⁴
9,32	3/8 P	1,1	.043	3610	61 PMM3	3610 007 1000 ¹	3610 007 1001 ²	3610 660 6000 ⁴
9,32	3/8	1,3	.050	3650	33 RM	3652 007 1000 ¹	3652 007 1001 ²	3824 660 6020 ⁴
9,32	3/8	1,3	.050	3662	33 RM3	3652 007 1000 ¹	3652 007 1001 ²	3824 660 6020 ⁴
9,32	3/8	1,3	.050	3654	33 RMF	3652 007 1000 ¹	3652 007 1001 ²	3824 660 6020 ⁴
9,32	3/8	1,3	.050	3623	33 RS	3621 007 1000 ¹	3621 007 1001 ²	3824 660 6020 ⁴
9,32	3/8	1,3	.050	3624	33 RS3	3621 007 1000 ¹	3621 007 1001 ²	3824 660 6020 ⁴
9,32	3/8	1,3	.050	3874	33 RSK	3898 007 1000 ¹	3898 007 1001 ²	3824 660 6020 ⁴
9,32	3/8	1,3	.050	3676	33 RSF	3621 007 1000 ¹	3621 007 1001 ²	3824 660 6020 ⁴
9,32	3/8	1,3	.050	3674	33 RSLH	3673 007 1000 ¹	3673 007 1001 ²	3824 660 6020 ⁴
9,32	3/8	1,3	.050	3679	33 RSL	3673 007 1000 ¹	3673 007 1001 ²	3824 660 6020 ⁴
9,32	3/8	1,3	.050	3672	33 RSLF	3673 007 1000 ¹	3673 007 1001 ²	3824 660 6020 ⁴
9,32	3/8	1,3	.050	3681	33 RD3	3683 007 1000 ¹	3683 007 1001 ²	3824 660 6020 ⁴
9,32	3/8	1,5	.058	3651	35 RM	3652 007 1000 ¹	3652 007 1001 ²	3824 660 6020 ⁴
9,32	3/8	1,5	.058	3622	35 RS	3621 007 1000 ¹	3621 007 1001 ²	3824 660 6020 ⁴
9,32	3/8	1,5	.058	3677	35 RSF	3621 007 1000 ¹	3621 007 1001 ²	3824 660 6020 ⁴
9,32	3/8	1,5	.058	3682	35 RD3	3683 007 1000 ¹	3683 007 1001 ²	3824 660 6020 ⁴

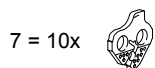
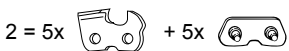
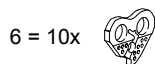
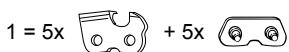

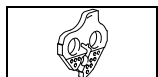
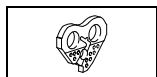
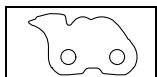

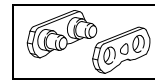
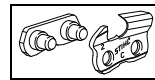
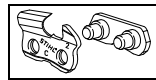
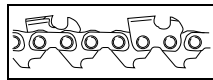
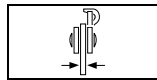
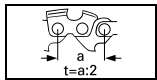

-	3669 662 1050 ⁶	3669 662 1150 ⁷	
-	3660 662 1050 ⁶		
-	3660 662 1050 ⁶		
-	3862 662 1050 ⁶		TI 58.2013
-	3862 662 1050 ⁶	3632 662 1150 ⁷	TI 58.2013
-	3862 662 1050 ⁶		
-	3862 662 1050 ⁶	3632 662 1150 ⁷	
-	3863 662 1050 ⁶		TI 58.2013
-	3863 662 1050 ⁶	3633 662 1150 ⁷	TI 58.2013
-	3863 662 1050 ⁶		
-	3863 662 1050 ⁶	3633 662 1150 ⁷	
-	3603 662 1050 ⁶		TI 58.2013
-	3603 662 1050 ⁶	3634 662 1150 ⁷	TI 58.2013
-	3603 662 1050 ⁶		
-	3603 662 1050 ⁶	3634 662 1150 ⁷	
-	3997 662 1050 ⁶	3636 662 1150 ⁷	
-	3997 662 1050 ⁶	3636 662 1150 ⁷	
-	3997 662 1050 ⁶		TI 40.2008
-	3997 662 1050 ⁶		TI 40.2008
-	3997 662 1050 ⁶		TI 40.2008
-	3997 662 1050 ⁶		
-	3997 662 1050 ⁶	3636 662 1150 ⁷	
-	3610 662 1050 ⁶	3610 662 1150 ⁷	TI 31.2007
-	3833 662 1050 ⁶		
-	3833 662 1050 ⁶	3624 662 1150 ⁷	
-	3833 662 1050 ⁶		
-	3833 662 1050 ⁶	3624 662 1150 ⁷	
-	3833 662 1050 ⁶		
-	3833 662 1050 ⁶		
-	3833 662 1050 ⁶		
-	3833 662 1050 ⁶		
-	3833 662 1050 ⁶	3624 662 1150 ⁷	TI 58.2013
-	3844 662 1050 ⁶		
-	3844 662 1050 ⁶		
-	3844 662 1050 ⁶		
-	3844 662 1050 ⁶	3625 662 1150 ⁷	TI 58.2013





mm in

mm in

9,32	3/8	1,6	.063	3653	36 RMX	3653 007 1000 ¹	3653 007 1001 ²	3824 660 6020 ⁴
9,32	3/8	1,6	.063	3652	36 RM	3652 007 1000 ¹	3652 007 1001 ²	3824 660 6020 ⁴
9,32	3/8	1,6	.063	3664	36 RM3	3652 007 1000 ¹	3652 007 1001 ²	3824 660 6020 ⁴
9,32	3/8	1,6	.063	3621	36 RS	3621 007 1000 ¹	3621 007 1001 ²	3824 660 6020 ⁴
9,32	3/8	1,6	.063	3626	36 RS3	3621 007 1000 ¹	3621 007 1001 ²	3824 660 6020 ⁴
9,32	3/8	1,6	.063	3898	36 RSK	3898 007 1000 ¹	3898 007 1001 ²	3824 660 6020 ⁴
9,32	3/8	1,6	.063	3675	36 RSLH	3673 007 1000 ¹	3673 007 1001 ²	3824 660 6020 ⁴
9,32	3/8	1,6	.063	3680	36 RSL	3673 007 1000 ¹	3673 007 1001 ²	3824 660 6020 ⁴
9,32	3/8	1,6	.063	3678	36 RSF	3621 007 1000 ¹	3621 007 1001 ²	3824 660 6020 ⁴
9,32	3/8	1,6	.063	3673	36 RSLF	3673 007 1000 ¹	3673 007 1001 ²	3824 660 6020 ⁴
9,32	3/8	1,6	.063	3683	36 RD3	3683 007 1000 ¹	3683 007 1001 ²	3824 660 6020 ⁴
9,32	3/8	1,6	.063	3944	36 RDR	3944 007 1000 ¹	3944 007 1001 ²	3824 660 6020 ⁴
10,26	.404	1,5	.058	3924	45 RSF	3946 007 1000 ¹	3946 007 1001 ²	3812 660 6020 ³
10,26	.404	1,6	.063	3812	46 RC	3812 007 1000 ¹	3812 007 1001 ²	3812 660 6020 ³
10,26	.404	1,6	.063	3958	46 RCX	3958 007 1000 ¹	3958 007 1001 ²	3812 660 6020 ³
10,26	.404	1,6	.063	3895	46 RCXK	3895 007 1000 ¹	3895 007 1001 ²	3812 660 6020 ³
10,26	.404	1,6	.063	3668	46 RM	3668 007 1000 ¹	3668 007 1001 ²	3812 660 6020 ³
10,26	.404	1,6	.063	3860	46 RMK	3860 007 1000 ¹	3860 007 1001 ²	3812 660 6020 ³
10,26	.404	1,6	.063	3838	46 RMX	3838 007 1000 ¹	3838 007 1001 ²	3812 660 6020 ³
10,26	.404	1,6	.063	3671	46 RMF	3668 007 1000 ¹	3668 007 1001 ²	3812 660 6020 ³
10,26	.404	1,6	.063	3946	46 RS	3946 007 1000 ¹	3946 007 1001 ²	3812 660 6020 ³
10,26	.404	1,6	.063	3846	46 RSK	3846 007 1000 ¹	3846 007 1001 ²	3812 660 6020 ³
10,26	.404	1,6	.063	3911	46 RSF	3946 007 1000 ¹	3946 007 1001 ²	3812 660 6020 ³
10,26	.404	1,6	.063	3851	46 RSLF	3877 007 1000 ¹	3877 007 1001 ²	3812 660 6020 ³

1 = 5x  + 5x 

6 = 10x 

2 = 5x  + 5x 

7 = 10x 

3 = 8x  + 8x 

4 = 9x  + 9x 

5 = 11x  + 11x 

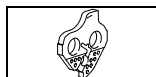
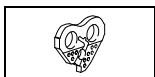
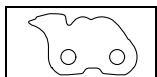

-	3725 662 1050 ⁶		TI 03.2008
-	3725 662 1050 ⁶		
-	3725 662 1050 ⁶	3626 662 1150 ⁷	
-	3725 662 1050 ⁶		
-	3725 662 1050 ⁶	3626 662 1150 ⁷	
-	3725 662 1050 ⁶		

-	3725 662 1050 ⁶		
-	3725 662 1050 ⁶		
-	3725 662 1050 ⁶		
-	3725 662 1050 ⁶		
-	3725 662 1050 ⁶	3626 662 1150 ⁷	TI 58.2013
3944 662 5300	3725 662 1050 ⁶		

-	3836 662 1050 ⁶		
-	3712 662 1050 ⁶		
-	3712 662 1050 ⁶		
-	3712 662 1050 ⁶		
-	3712 662 1050 ⁶		
-	3712 662 1050 ⁶		
-	3712 662 1050 ⁶		
-	3712 662 1050 ⁶		
-	3712 662 1050 ⁶		
-	3712 662 1050 ⁶		
-	3712 662 1050 ⁶		
-	3712 662 1050 ⁶		

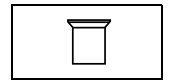
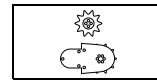
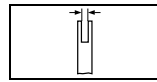
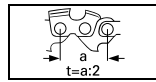
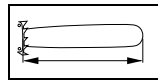

	cm	in	mm	in	mm	in			
3005 000 6405	30	12	6,35	1/4	1,3	.050	3005 650 9904	13	0000 974 0421
3005 000 6409	35	14	6,35	1/4	1,3	.050	3005 650 9904	13	0000 974 0421
3005 000 6413	40	16	6,35	1/4	1,3	.050	3005 650 9904	13	0000 974 0421
3003 000 6613	40	16	8,25	.325	1,3	.050	3003 650 9940	11	0000 974 0420
3003 000 6617	45	18	8,25	.325	1,3	.050	3003 650 9940	11	0000 974 0420
3003 008 6621	50	20	8,25	.325	1,3	.050	3003 650 9940	11	0000 974 0420
3003 000 5006	32	13	8,25	.325	1,5	.058	3003 650 9927	11	0000 974 0420
3003 000 5011	37	15	8,25	.325	1,5	.058	3003 650 9927	11	0000 974 0420
3003 000 5306	32	13	8,25	.325	1,6	.063	3003 650 9926	11	0000 974 0420
3003 000 6811	37	15	8,25	.325	1,6	.063	3003 650 9926	11	0000 974 0420
3003 000 6813	40	16	8,25	.325	1,6	.063	3003 650 9926	11	0000 974 0420
3003 008 6817	45	18	8,25	.325	1,6	.063	3003 650 9926	11	0000 974 0420
3003 008 6821	50	20	8,25	.325	1,6	.063	3003 650 9926	11	0000 974 0420
3005 000 7013	40	16	8,25	.325	1,3	.050	3003 650 9940	11	0000 974 0420
3005 008 7017	45	18	8,25	.325	1,3	.050	3003 650 9940	11	0000 974 0420
3005 000 5009	35	14	8,25	.325	1,5	.058	3003 650 9927	11	0000 974 0420
3005 000 4709	35	14	8,25	.325	1,6	.063	3003 650 9926	11	0000 974 0420
3005 008 4713	40	16	8,25	.325	1,6	.063	3003 650 9926	11	0000 974 0420
3005 008 4717	45	18	8,25	.325	1,6	.063	3003 650 9926	11	0000 974 0420
3003 000 6306	32	13	9,32	3/8 P	1,3	.050	3005 650 9903	9	0000 974 0421
3003 000 6313	40	16	9,32	3/8 P	1,3	.050	3005 650 9903	9	0000 974 0421
3003 000 6317	45	18	9,32	3/8 P	1,3	.050	3005 650 9903	9	0000 974 0421
3005 000 7405	30	12	9,32	3/8 P	1,3	.050	3005 650 9903	9	0000 974 0421
3005 000 4805	30	12	9,32	3/8 P	1,3	.050	3005 650 9903	9	0000 974 0421
3005 000 4809	35	14	9,32	3/8 P	1,3	.050	3005 650 9903	9	0000 974 0421
3005 000 7409	35	14	9,32	3/8 P	1,3	.050	3005 650 9903	9	0000 974 0421
3005 000 7413	40	16	9,32	3/8 P	1,3	.050	3005 650 9903	9	0000 974 0421
3005 008 4813	40	16	9,32	3/8 P	1,3	.050	3005 650 9903	9	0000 974 0421
3005 000 4817	45	18	9,32	3/8 P	1,3	.050	3005 650 9903	9	0000 974 0421
3002 000 9123	53	21	9,32	3/8	1,6	.063	3003 650 9922	10	0000 974 0420
3003 000 2221	50	20	9,32	3/8	1,3	.050	3003 650 2551	11	0000 974 0503
3003 000 2231	63	25	9,32	3/8	1,3	.050	3003 650 2551	11	0000 974 0503
3003 000 8913	40	16	9,32	3/8	1,3	.050	3003 650 9928	10	0000 974 0420
3003 000 8917	45	18	9,32	3/8	1,3	.050	3003 650 9928	10	0000 974 0420
3003 000 8921	50	20	9,32	3/8	1,3	.050	3003 650 9928	10	0000 974 0420
3003 000 7813	40	16	9,32	3/8	1,3	.050	3003 650 9938	11	0000 974 0420
3003 000 7817	45	18	9,32	3/8	1,3	.050	3003 650 9938	11	0000 974 0420
3003 000 7821	50	20	9,32	3/8	1,3	.050	3003 650 9938	11	0000 974 0420
3003 000 7831	63	25	9,32	3/8	1,3	.050	3003 650 9938	11	0000 974 0420
3003 000 8813	40	16	9,32	3/8	1,3	.050	3003 650 2551*	11	0000 974 0503
3003 000 8817	45	18	9,32	3/8	1,3	.050	3003 650 2551*	11	0000 974 0503
3003 000 8822	50	20	9,32	3/8	1,3	.050	3003 650 2551*	11	0000 974 0503
3003 000 8830	63	25	9,32	3/8	1,3	.050	3003 650 2551*	11	0000 974 0503
3003 000 8838	71	28	9,32	3/8	1,3	.050	3003 650 2551*	11	0000 974 0503
3003 000 8846	80	32	9,32	3/8	1,3	.050	3003 650 2551*	11	0000 974 0503
3003 000 8853	90	36	9,32	3/8	1,3	.050	3003 650 2551*	11	0000 974 0503
3003 000 2238	71	28	9,32	3/8	1,3	.050	3003 650 2551*	11	0000 974 0503
3003 000 2246	80	32	9,32	3/8	1,3	.050	3003 650 2551*	11	0000 974 0503
3003 000 2253	90	36	9,32	3/8	1,3	.050	3003 650 2551*	11	0000 974 0503

* = 

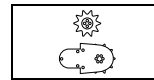
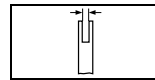
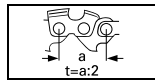
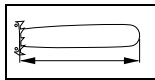

	cm	in	mm	in	mm	in			
3003 000 6106	32	13	9,32	3/8	1,6	.063	3003 650 9922	10	0000 974 0420
3003 000 6111	37	15	9,32	3/8	1,6	.063	3003 650 9922	10	0000 974 0420
3003 000 6113	40	16	9,32	3/8	1,6	.063	3003 650 9922	10	0000 974 0420
3003 008 6117	45	18	9,32	3/8	1,6	.063	3003 650 9922	10	0000 974 0420
3003 008 6121	50	20	9,32	3/8	1,6	.063	3003 650 9922	10	0000 974 0420
3003 000 5211	37	15	9,32	3/8	1,6	.063	3003 650 9935	11	0000 974 0420
3003 000 5213	40	16	9,32	3/8	1,6	.063	3003 650 9935	11	0000 974 0420
3003 000 5217	45	18	9,32	3/8	1,6	.063	3003 650 9935	11	0000 974 0420
3003 000 5221	50	20	9,32	3/8	1,6	.063	3003 650 9935	11	0000 974 0420
3003 000 5231	63	25	9,32	3/8	1,6	.063	3003 650 9935	11	0000 974 0420
3003 000 9413	40	16	9,32	3/8	1,6	.063	3003 650 2551*	11	0000 974 0503
3003 000 9417	45	18	9,32	3/8	1,6	.063	3003 650 2551*	11	0000 974 0503
3003 000 9421	50	20	9,32	3/8	1,6	.063	3003 650 2551*	11	0000 974 0503
3003 000 9425	55	22	9,32	3/8	1,6	.063	3003 650 2551*	11	0000 974 0503
3003 000 6038	71	28	9,32	3/8	1,6	.063	3003 650 2551*	11	0000 974 0503
3003 000 6041	75	30	9,32	3/8	1,6	.063	3003 650 2551*	11	0000 974 0503
3003 000 6046	80	32	9,32	3/8	1,6	.063	3003 650 2551*	11	0000 974 0503
3003 000 8853	90	36	9,32	3/8	1,3	.050	3003 650 2551*	11	0000 974 0503
3003 000 6053	90	36	9,32	3/8	1,6	.063	3003 650 2551*	11	0000 974 0503
3003 000 9821	50	20	9,32	3/8	1,6	.063	3003 650 2539*	13	0000 974 0503
3003 000 9842	75	30	9,32	3/8	1,6	.063	3003 650 2539*	13	0000 974 0503
3003 000 9852	90	36	9,32	3/8	1,6	.063	3003 650 2539*	13	0000 974 0503
3003 000 9853	90	36	9,32	3/8	1,6	.063	3003 650 2539*	13	0000 974 0503
3003 000 2021	50	20	9,32	3/8	1,6	.063	3003 650 2551	11	0000 974 0503
3003 000 2031	63	25	9,32	3/8	1,6	.063	3003 650 2551	11	0000 974 0503
3003 000 2038	71	28	9,32	3/8	1,6	.063	3003 650 2551	11	0000 974 0503
3003 000 2046	80	32	9,32	3/8	1,6	.063	3003 650 2551	11	0000 974 0503
3003 000 2053	90	36	9,32	3/8	1,6	.063	3003 650 2551	11	0000 974 0503
3002 000 9715	43	17	10,26	.404	1,6	.063	3003 650 2538*	12	0000 974 0503
3002 000 9723	53	21	10,26	.404	1,6	.063	3003 650 2538*	12	0000 974 0503
3002 000 9731	63	25	10,26	.404	1,6	.063	3003 650 2538*	12	0000 974 0503
3002 000 9741	75	30	10,26	.404	1,6	.063	3003 650 2538*	12	0000 974 0503
3002 000 9753	90	36	10,26	.404	1,6	.063	3003 650 2538*	12	0000 974 0503
3002 000 9757	105	41	10,26	.404	1,6	.063	3003 650 2538*	12	0000 974 0503
3002 000 9576	150	59	10,26	.404	1,6	.063	3003 650 2538*	12	0000 974 0503
3003 000 9721	50	20	10,26	.404	1,6	.063	3003 650 2538*	12	0000 974 0503
3003 000 9731	63	25	10,26	.404	1,6	.063	3003 650 2538*	12	0000 974 0503
3003 000 7346	80	32	10,26	.404	1,6	.063	3003 650 2555*	10	0000 974 0503
3003 000 7353	90	36	10,26	.404	1,6	.063	3003 650 2555*	10	0000 974 0503

STIHL GBM- / GBE-

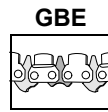
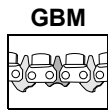
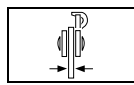
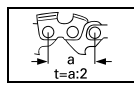
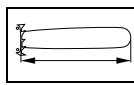
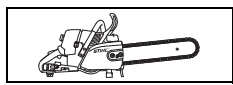

cm in. mm in. mm in.

STIHL GS 461	30	12	9,32	3/8	1,6	.063	3210 000 0054	3211 000 0054	3210 007 1000	3210 662 1151
	40	16	9,32	3/8	1,6	.063	3210 000 0064	3211 000 0064	3210 007 1000	3210 662 1151

STIHL Rollomatic G-

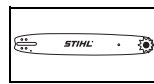
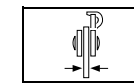
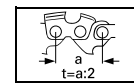
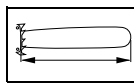
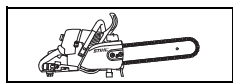

cm in. mm in. mm in.

STIHL
Rollomatic G

STIHL GS 461	30	12	9,32	3/8	1,6	.063	27	27	3006 000 1205	14
	40	16	9,32	3/8	1,6	.063	32	32	3006 000 1213	14



3210 662 1150
3210 662 1150

0456 689 0000. VA3.B18. FST. Printed in Germany

Gedruckt auf chlorefrei gebleichtem Papier
Printed on chlorine-free paper
Imprimé sur papier blanchi sans chlore
Impreso en papel blanqueado sin cloro